

Technics

TAPE DECK

RS-M240X

OPERATING INSTRUCTIONS



Before operating this set, please read these instructions completely.

IMPORTANT (For United Kingdom)

THE WIRES IN THIS MAINS LEAD ARE COLOURED IN ACCORDANCE WITH THE FOLLOWING CODE:

BLUE: NEUTRAL **BROWN: LIVE**

As the colours of the wires in the mains lead of this apparatus may not correspond with the coloured markings identifying the terminals in your plug, proceed as follows:

- * The wire which is coloured blue must be connected to the terminal which is marked with the letter N or coloured black.
- * The wire which is coloured brown must be connected to the terminal which is marked with the letter L or coloured red.

If a 13-amp (B.S.1363) plug is used, a 3-amp fuse must be fitted, or if any other type of plug is used, a 5-amp fuse must be fitted either in the plug or adaptor or at the distribution board.

1

- VOLTAGE ADJUSTMENT
- SPÄNNINGSJUSTERING
- REGLAGE DU VOLTAGE
- INSTELLING VAN DE NETSPANNING
- INDSTLLING AF SPÆNDINGEN
- EINSTELLEN DER SPANNUNG
- REGOLAZIONE DEL VOLTAGGIO

Preset power voltage; 240 V for Australia and 220 V for Europe

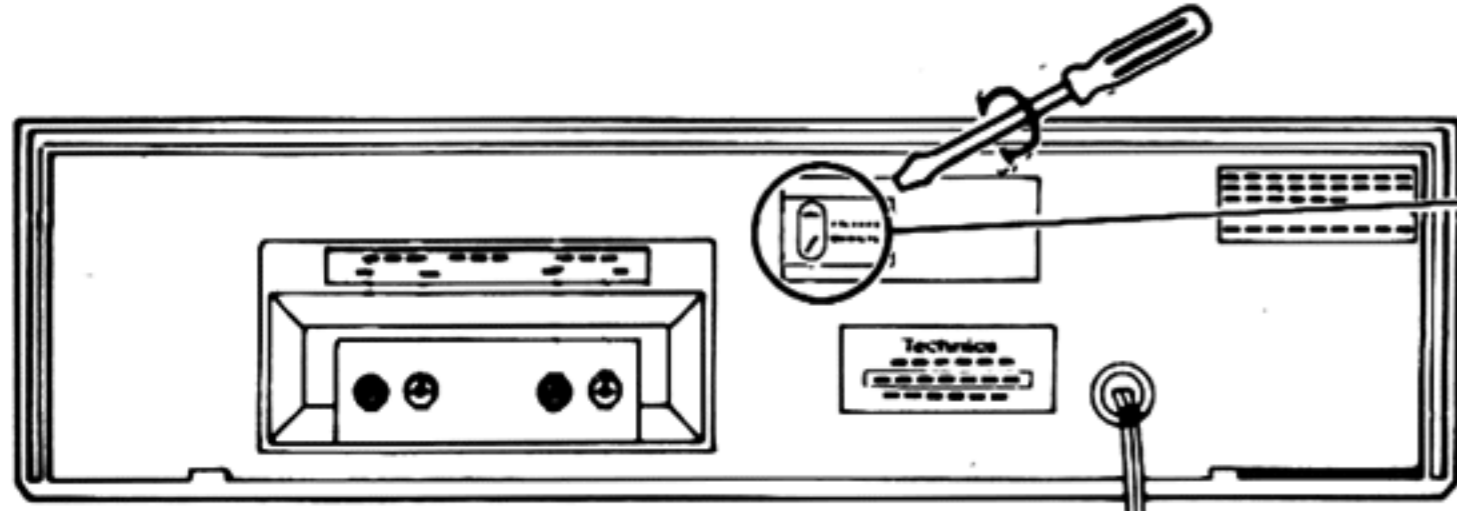

VOLTAGE SELECTOR

- SETTING OF VOLTAGE SELECTOR
- INSTALLNING AV SPÄNNINGSVALJAREN
- REGLAGE DU SELECTEUR DE VOLTAGE
- STAND VAN DE NETSPANNINGS SELEKTOR
- SPÆNDINGSVÆLGERENS STILLING
- EINSTELLUNG DES SPANNUNGSWAHLERS
- REGOLAZIONE DEL SELETTORE DEL VOLTAGGIO

	110V	125V	220V	240V
• LOCAL VOLTAGE	AC: 100, 105, 110V	AC: 115, 117, 120, 125V	AC: 200, 210, 220V	AC: 225, 230, 240, 250V
• LOKAL SPÄNNING				
• TENSION LOCALE				
• PLAATSELIJKE NETSPANNING				
• DEN STEDLIGE NETSPÆNDING				
• ORTL. NETSPANNUNG				
• TENSIONE LOCALE				
	50-60 Hz	50-60 Hz	50-60 Hz	50-60 Hz

2

- ABOUT CASSETTE TAPE
- OM KASSETTBAND
- LES CASSETTES
- KASSETTE BAND
- OM KASSETTEBÅND
- DIE CASSETTE
- NOZIONI CIRCA LE CASSETTE

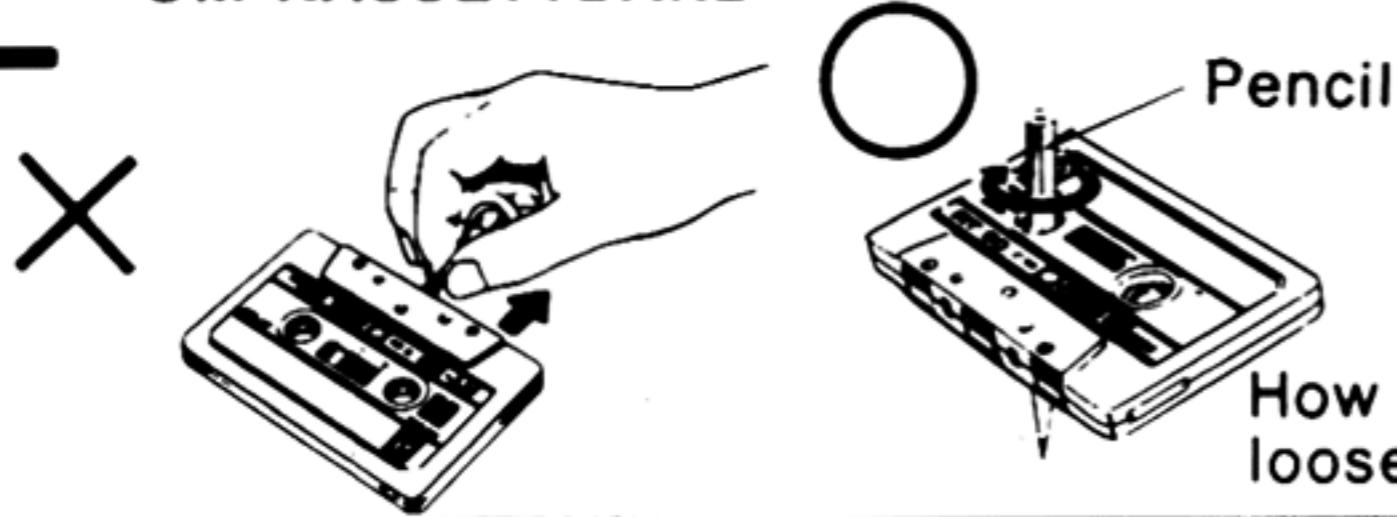

How to correct tape looseness.

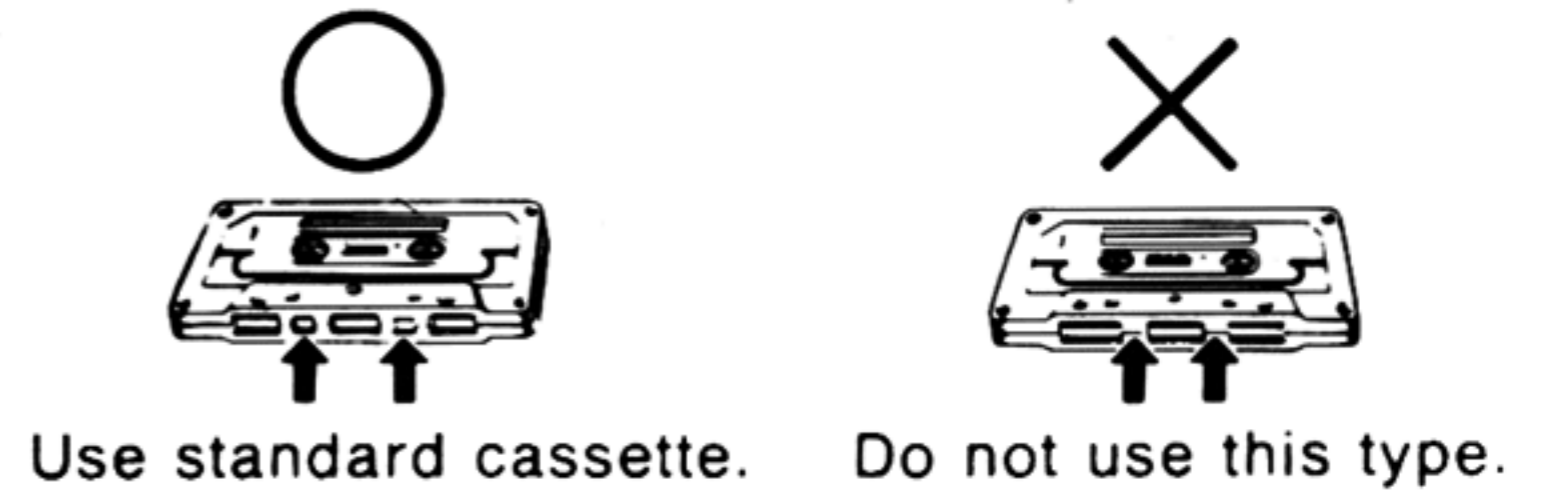

Use standard cassette. Do not use this type.

3

- ACCIDENTAL-ERASE PREVENTION
- SKYDD MOT OAVSIKTLIG RADERING
- DISPOSITIF DE PREVENTION D'ENREGISTREMENT
- VOORKOMEN VAN ABUSIEVELIJK WISSEN
- BESKYTTELSE MOD SLETNING
- LÖSCHSCHUTZVORRICHTUNG
- PREVENZIONE CANCELLAMENTO ACCIDENTALE



For side 1 Voor kant 1 Für Seite 1
 För sida 1 For side 1 Per il lato 1
 Pour le côté 1

For side 2 Voor kant 2 Für Seite 2
 För sida 2 For side 2 Per il lato 2
 Pour le côté 2

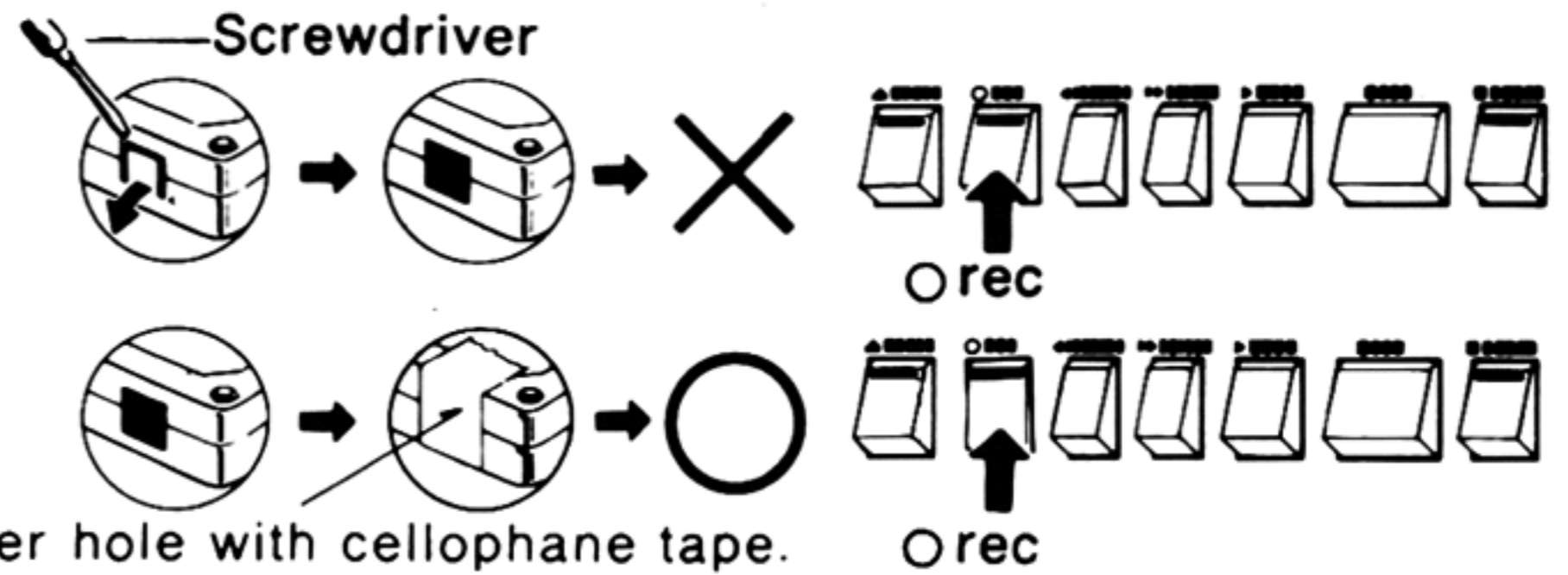

Cover hole with cellophane tape. Orec

4

- MAINTENANCE
- VÅRD
- Cleaning the head section
- Rengöring av bandhuvuddelen
- Nettoyage des têtes
- Operate in the numbered order.
- Gör som bilderna visar i nummerordning.
- Procéder par ordre numérique.
- ENTRETIEN
- ONDERHOUD
- Reinigen van de koppen
- Rensning af tonehoveddelen
- VEDLIGEHOLDELSE
- WARTUNG
- Voer de verrichtingen uit in de genummerde volgorde.
- Gå frem efter numrene.
- Das Gerät in der nummerierten Reihenfolge bedienen.
- Operare nell'ordine numerato;
- MANUNTENZIONE
- Reinigen des Tonkopfteils
- Plizia del traferro della testina

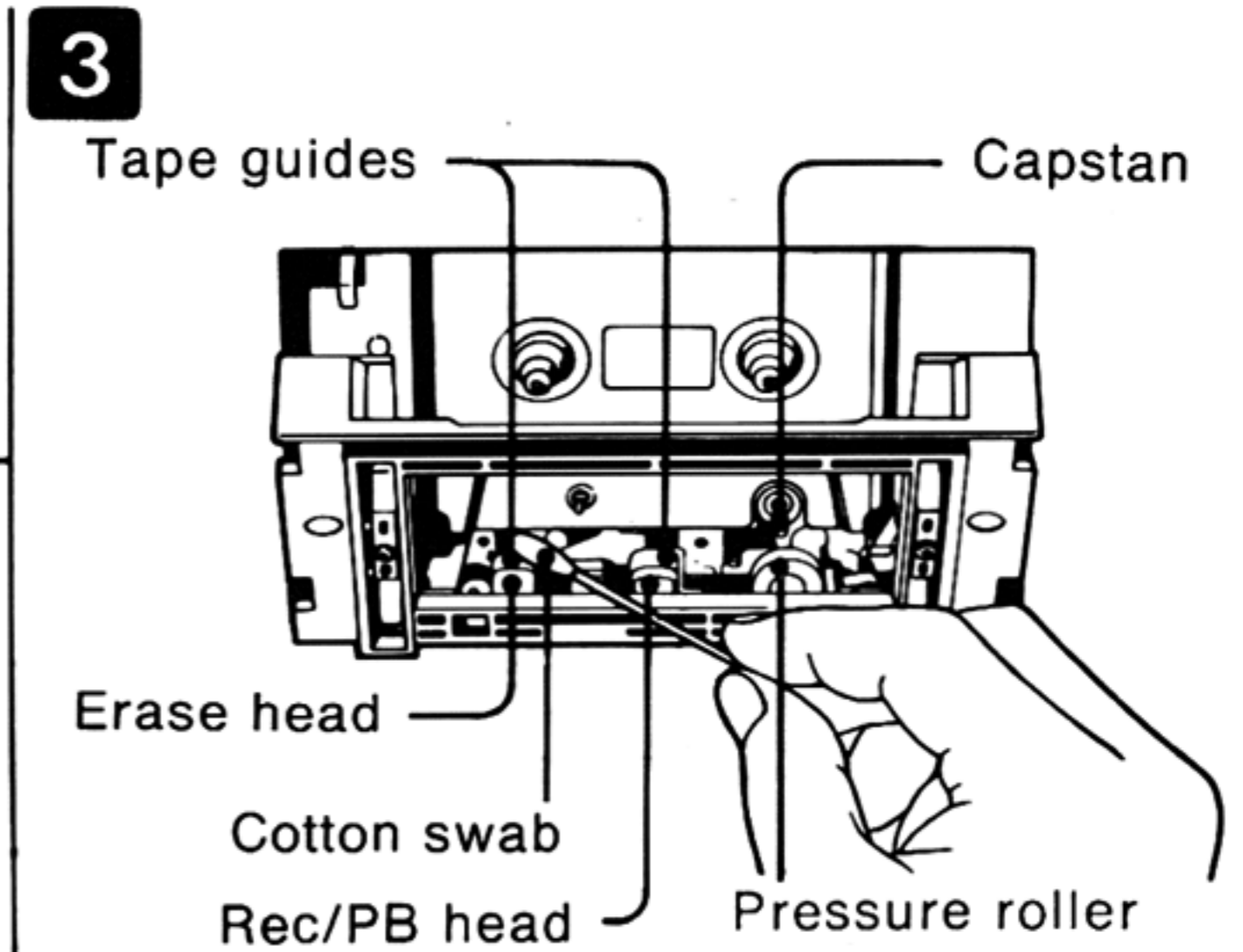
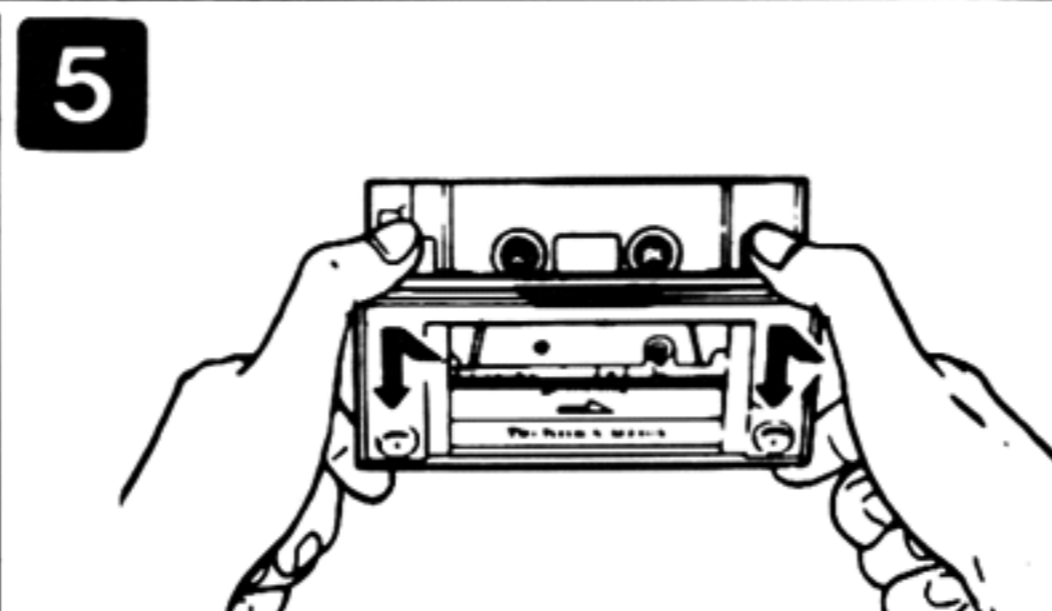
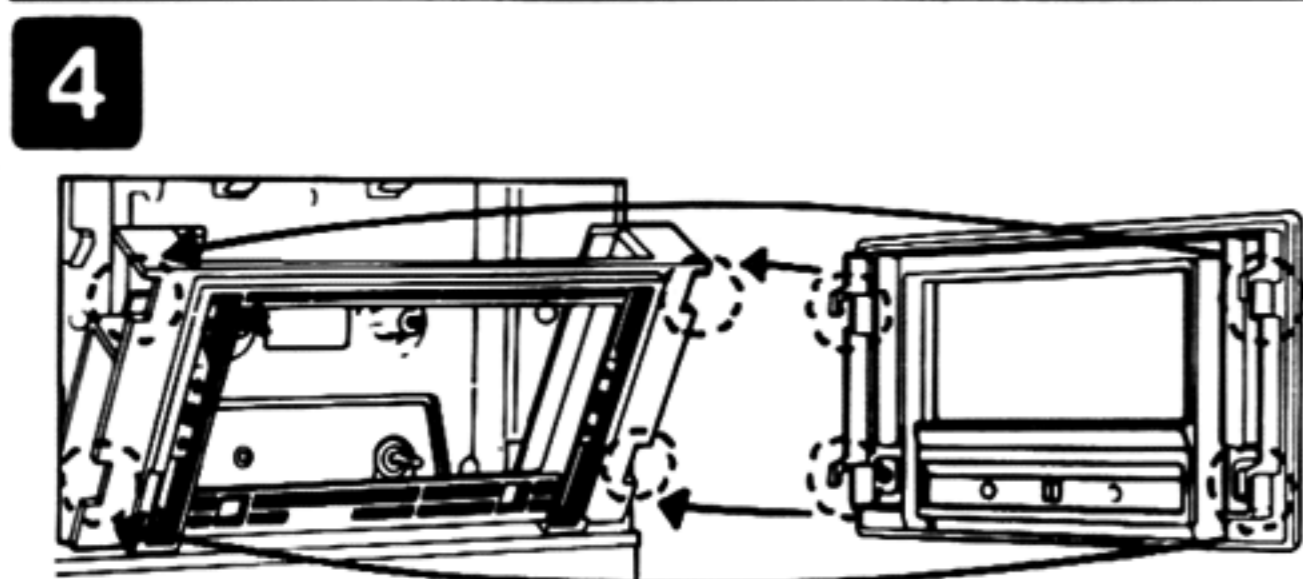
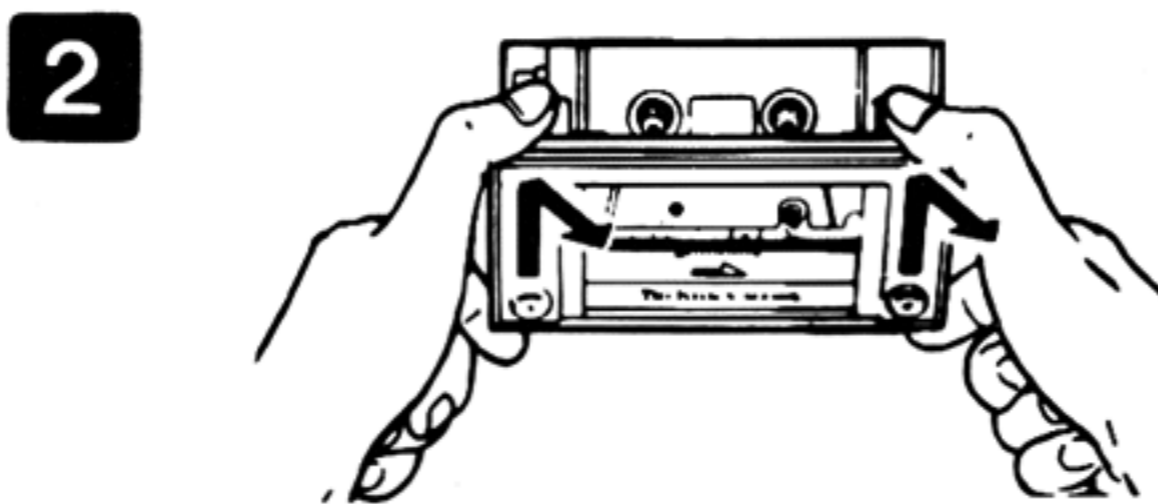
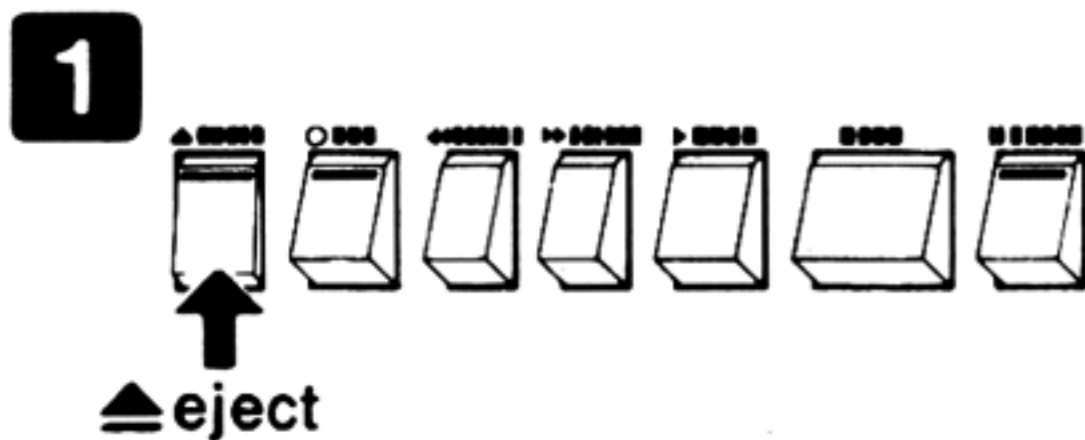

* The term dbx is a registered trademark of dbx Inc.
 ** 'Dolby' and the double-D symbol are trademarks of Dolby Laboratories.

5

• CONTROLS
• KONTROLLER

• LES COMMANDES
• BEDIENINGSKNOPPEN

• BETJENING
• BEDIENUNGSELEMENTE

• CONTROLLO

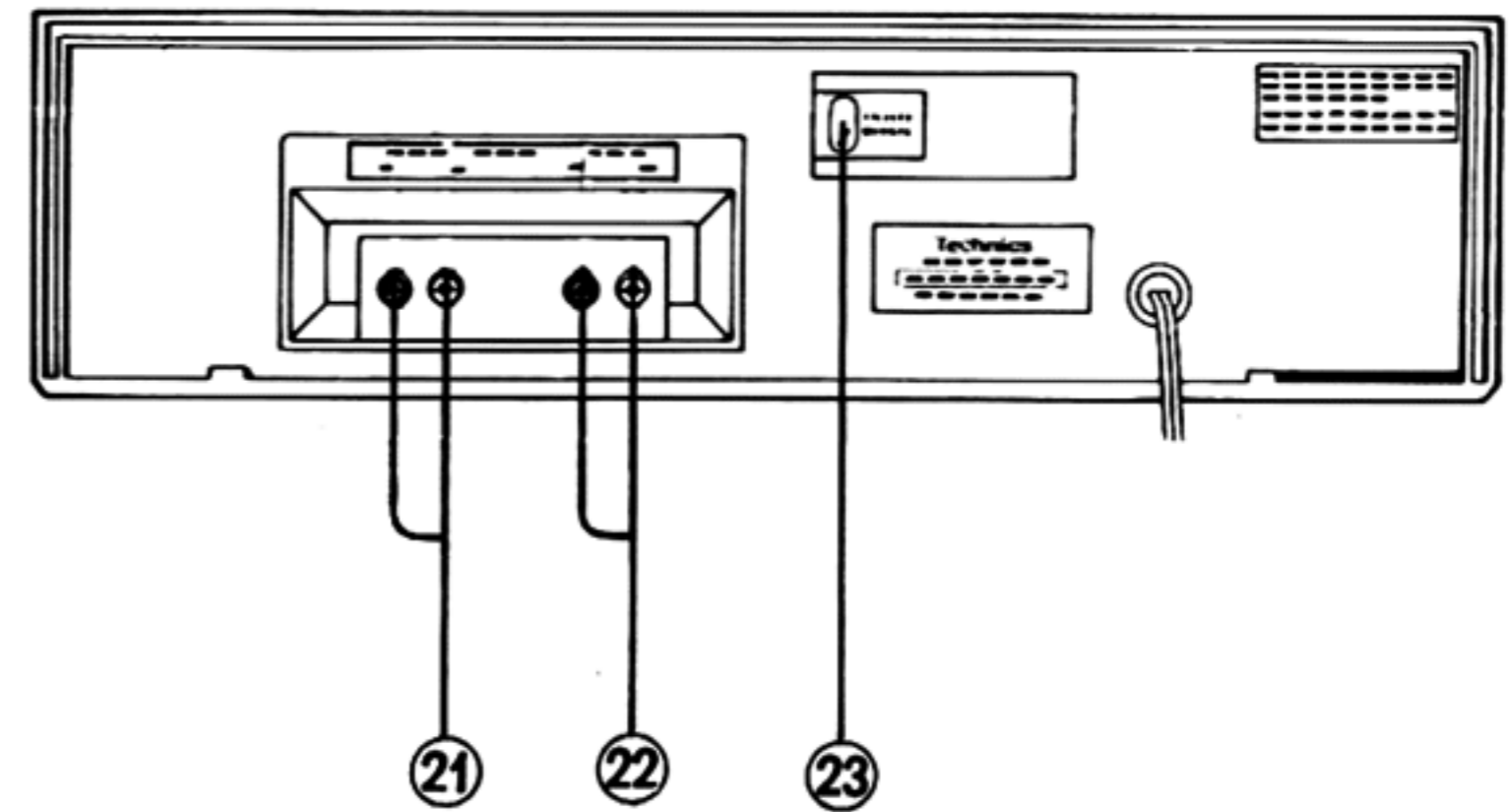
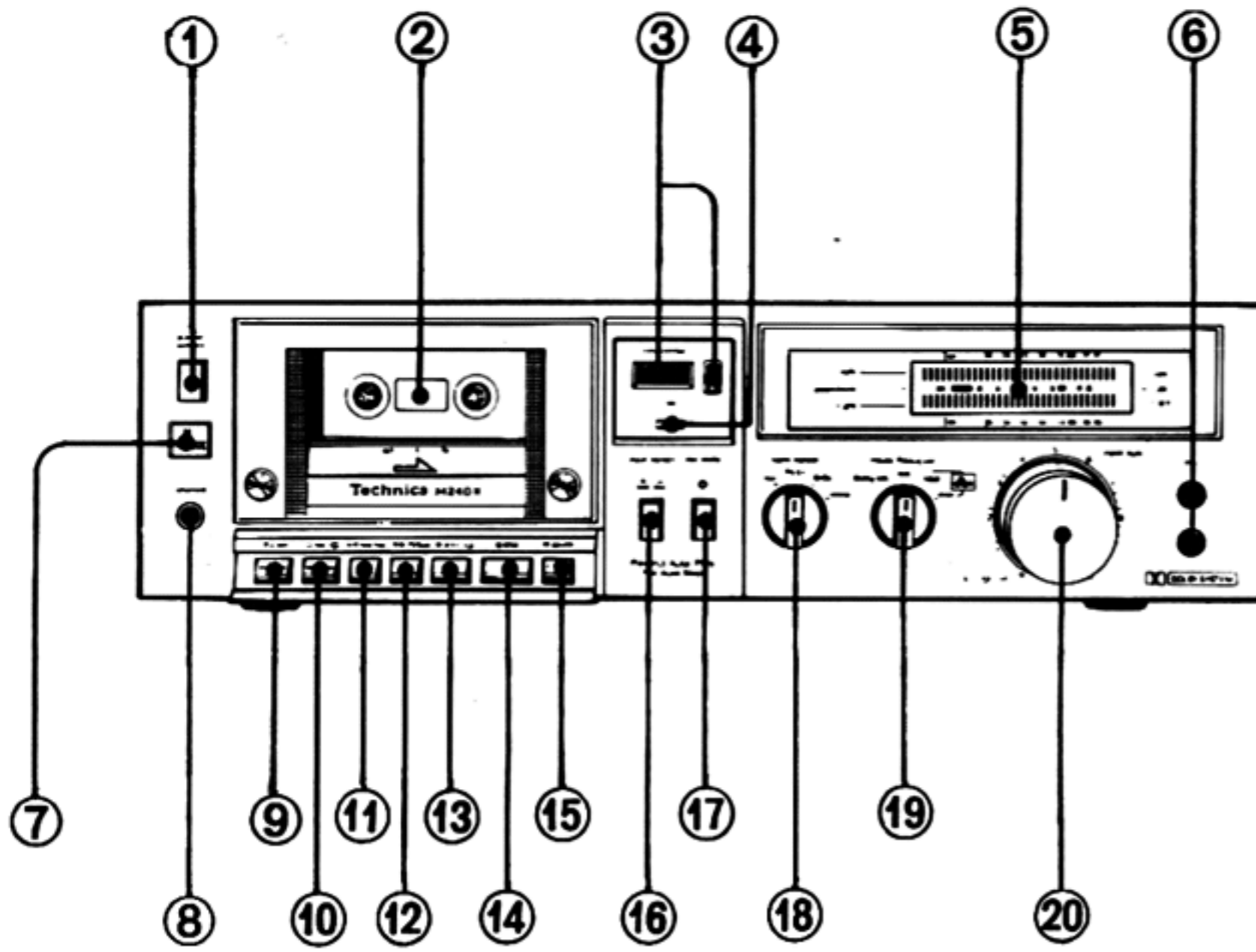

6

• CONNECTIONS
• ANSLUTNINGAR

• BRANCHEMENTS
• AANSLUITINGEN

• TILSLUTNING
• ANSCHLÜSSE

• CONNESSIONI

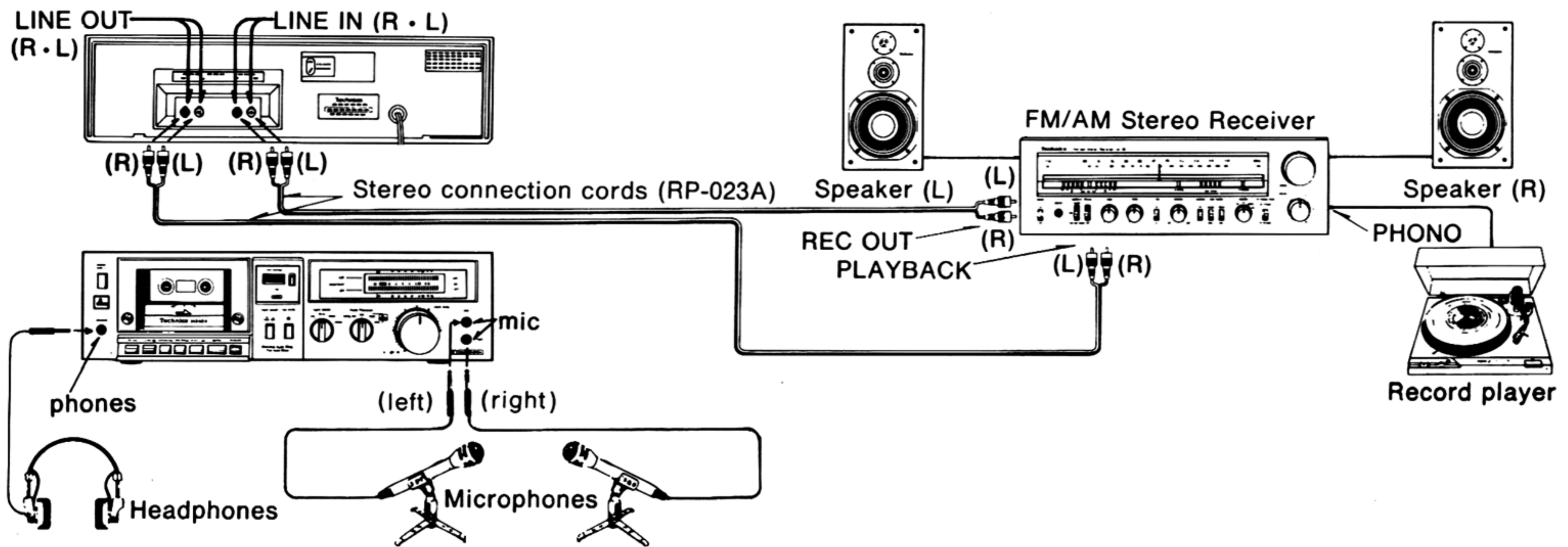

7

- TAPE SELECTOR SETTINGS FOR VARIOUS TAPES
- BANDVÄLJARENS LÄGE FÖR TYPER AV BAND
- POSITION DU SELECTEUR DE BANDE POUR DIFFERENTES BANDES
- STANDEN VAN DE BANDSOORTSELECTOR VOOR VERSCHILLENDE BANDSOORTEN
- INDSTILLING AF BÅNDVÆLGEREN FOR FORSKELLIGE BÅNDTYPER
- WAHLSCHALTERSTELLUNG FÜR VERSCHIEDENE BÄNDER
- POSIZIONI DEL SELETTORE DEL NASTRO PER I VARI TIPI DI NASTRO

Tape selector	Tape brand	Tape type
Nor (Normal)	Technics XD	C-46, C-60, C-90
	Technics LN	C-60, C-90
	BASF LHI	C-60, C-90
	BASF PROFESSIONAL I	C-60, C-90
	BASF SLH	C-60, C-90
	FUJI FX I	C-60, C-90
	MAXELL UD	C-60, C-90
	MAXELL UDXL I	C-60, C-90
	SONY AHF	C-60, C-90
	TDK AD	C-60, C-90
	Fe-Cr	BASF PROFESSIONAL III
SONY Fe-Cr		C-60
CrO ₂	Technics XA	C-46, C-60, C-90
	MAXELL UDXL II	C-46, C-60
	SCOTCH MASTER II	C-46, C-60
	TDK SA	C-46, C-60
Metal	FUJI FX II	C-60
	Technics MX	C-46, C-60, C-90
	FUJI SR	C-46, C-60, C-90
	MAXELL MX	C-46, C-60, C-90
	SCOTCH METAFINE	C-46, C-60, C-90
SONY METALLIC	C-46, C-60, C-90	
TDK MA	C-46, C-60, C-90	

8

- "Metal tape"
- "Metal tape"
- "Metal tape"

- "Metal tape"
- "Metal tape"

- "Metal tape"
- "Metal tape"

- "Metal tape" frequency response example
- Exempel på frekvensgång med "Metal tape"
- Exemple de courbe de réponse de la bande "Metal tape"
- Voorbeeld van weergavekarakteristiek van "Metal tape" band
- Frekvensgang for et "Metal tape"
- Frequenzgang des "Metal tape"
- Esempio risposta di frequenza nastro "Metal tape"

- "Metal tape" magnetic characteristics
- Magnetisk karakteristik för "Metal tape"
- Caractéristiques magnétiques de la bande "Metal tape"
- Magnetische karakteristieken van de "Metal tape" band
- Magnetisk karakteristik for "Metal tape"
- Magnetisierungskennlinie des "Metal tape"
- Caratteristiche nastro magnetico "Metal tape"

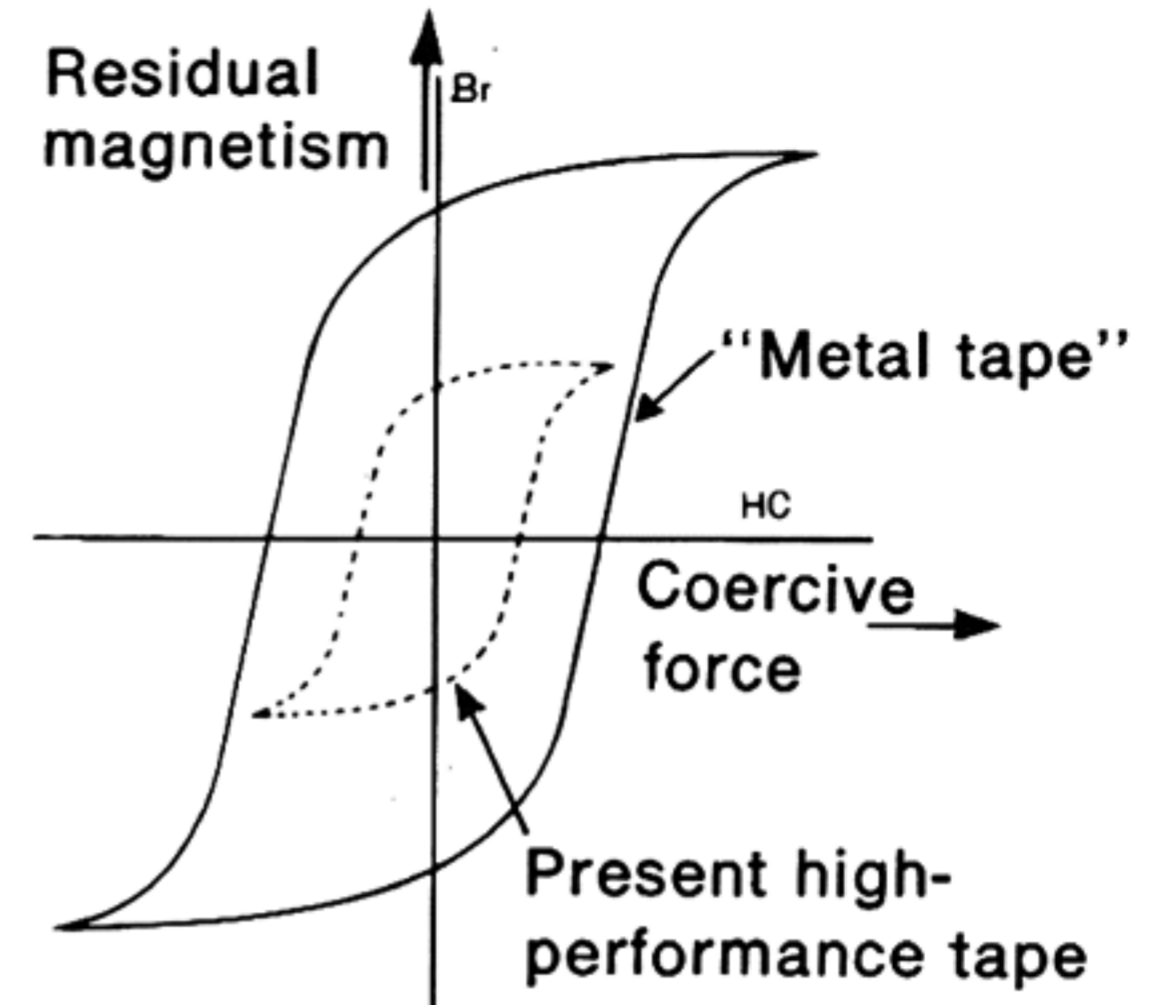
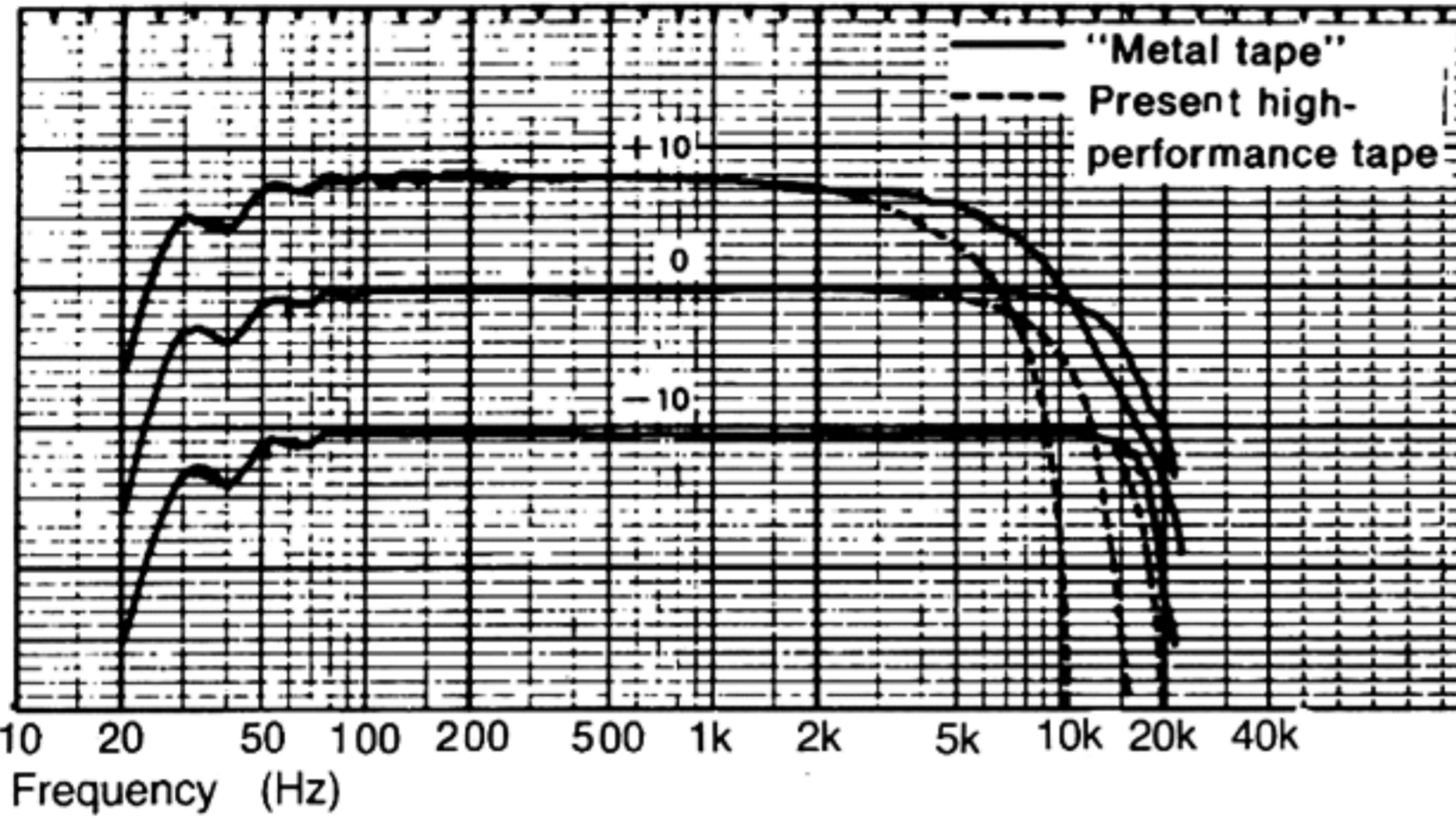

9

- CASSETTE INSERTION AND REMOVAL
- ILAGGNING OCH UTTAGNING AV KASSETTEN
- MISE EN PLACE ET ENLEVEMENT DES CASSETTES
- CASSETTE INLEGGEN EN UITNEMEN
- Operate in the numbered order.
- Gör som bilderna visar i nummerordning.
- Procédér par ordre numérique.
- Voer de handelingen uit in de genummerde volgorde.

- ISÆTNING OG UDTAGNING AF KASSETTEN
- EINLEGEN UND ENTNEHMEN DER CASSETTEN
- INSERZIONE ED ESPULSIONE DELLA CASSETTA

- Gå frem efter numrene.
- Das Gerät in der nummerierten Reihenfolge bedienen
- Operare nell'ordine numerato.

1

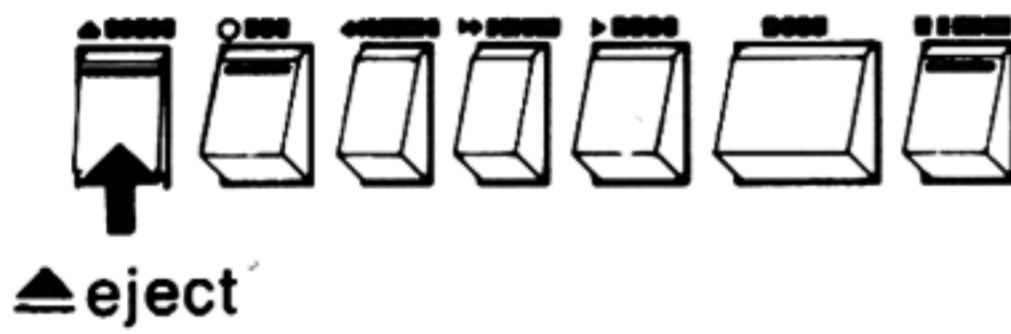

2

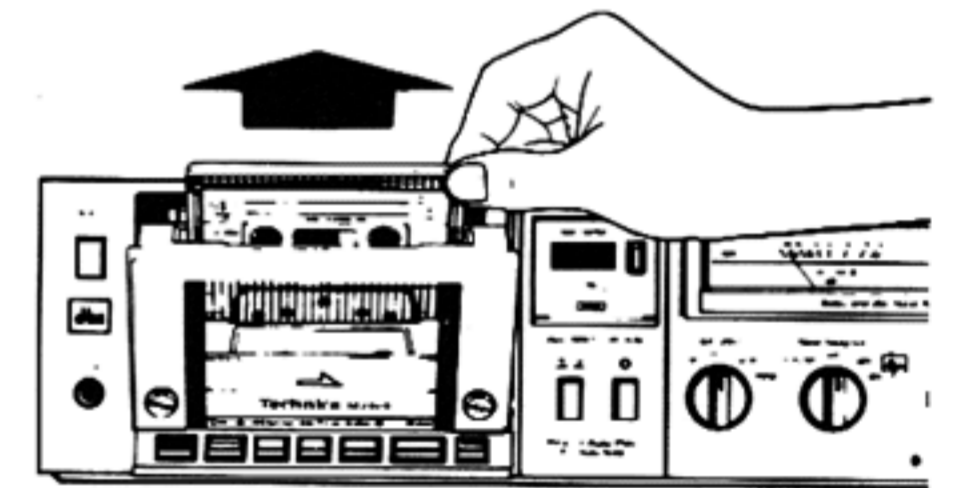
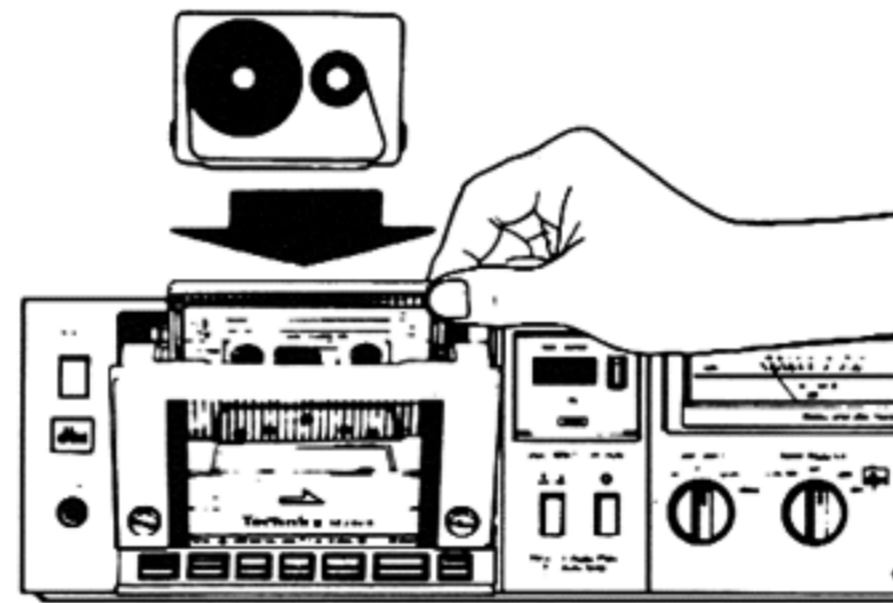

10

- PLAYBACK
- AVSPELNING

- LECTURE
- WEERGAVE

- AFSPIJNING
- WIEDERGABE

- RIPRODUZIONE

1

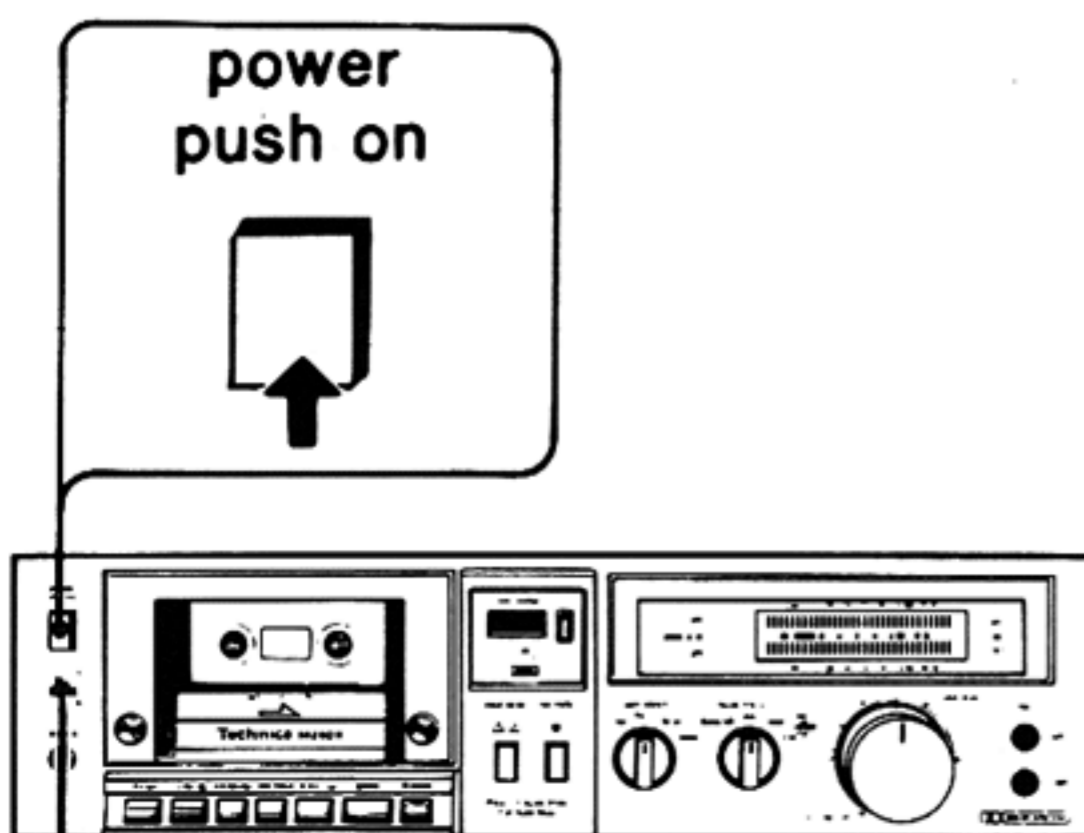

- The Indicator lights when the power is switched on. But it has nothing to do with the Noise reduction selector switch.
- Indikatoren tänds när strömbrytaren slås till. Detta har inget att göra med omkopplaren för brusreducering.
- Le témoin s'allume lorsque le courant est alimenté, mais ceci n'a rien à voir avec le sélecteur de réducteur de bruit.
- Bij het inschakelen van het apparaat licht de indikator op. Het oplichten van de indikator staat niet in verband met de stand van de ruisonderdrukkings-keuzeschakelaar.
- Indikatoren bliver tændt, når der tændes for strømmen. Men dette har ikke noget med støjreduktionsvalgsomskifteren at gøre.
- Bei Stromzufuhr leuchtet diese Anzeige. Dies hat jedoch nichts mit dem Wahlschalter für Rauschverminderung zu tun.
- L'indicoitare si accende quando si inserisce la corrente, ma ciò non riguarda il selettore di riduzione del rumore.

- 2**
- Refer to fig. 9-12.
 - Se fig. 9-12.
 - Se reporter à fig. 9-12.
 - Zie fig. 9-12.
 - Se fig. 9-12.
 - Siehe Abb. 9-12.
 - Rif. fig. 9-12.

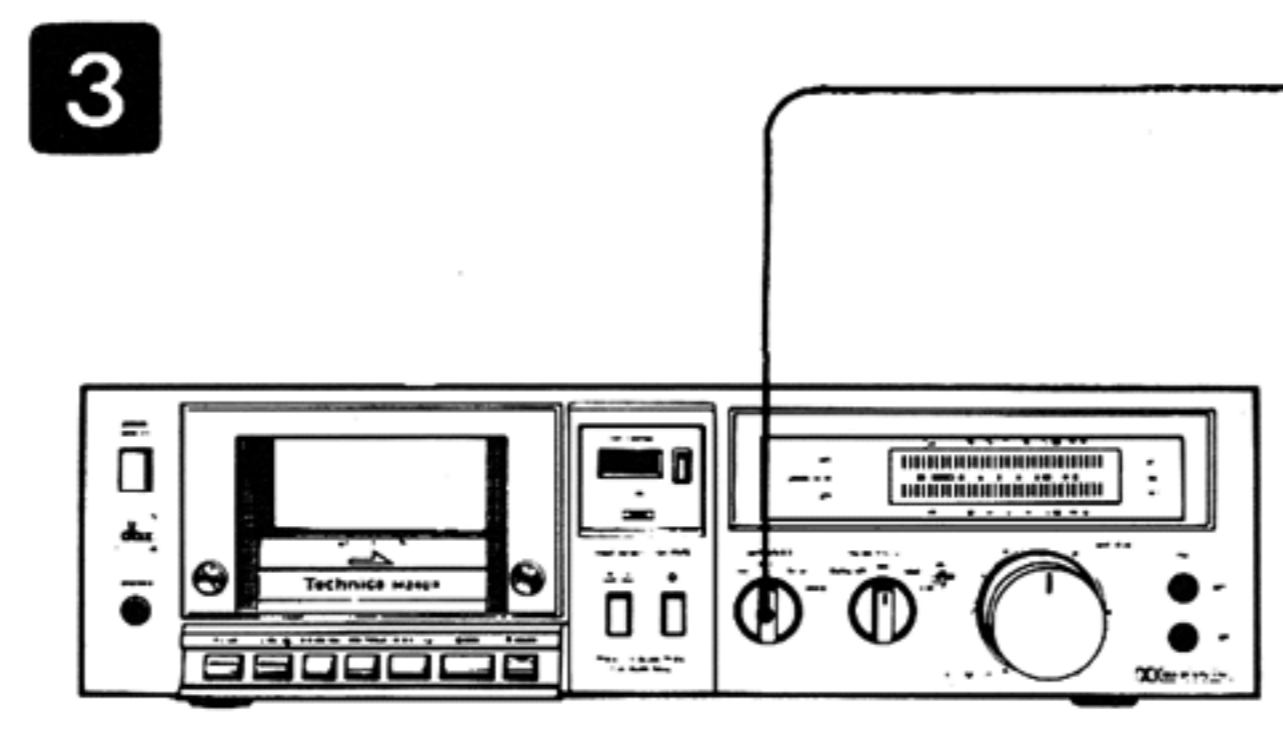

tape select
Nor. Fe-Cr CrO₂ Metal

- Refer to fig. 7.
- Se fig. 7.
- Se reporter à fig. 7.
- Zie fig. 7.
- Se fig. 7.
- Siehe Abb. 7.
- Rif. fig. 7.

4

Noise Reduction
Dolby NR. out tape disc

- See to page E-2, 3.
- Se sid SV-2, 3.
- Voir page F-2, 3, 4.
- Zie naar blad N-2,3,4.
- Se side D-2, 3.
- Siehe Seite D-2, 3, 4.
- Ved. pag. I-2, 3.

5

tape counter

6

play

7

bass-treble volume

FM/AM Stereo Receiver

8

phones

8

stop

11

- FAST FORWARD AND REWIND
- SNEL OPSPOLEN EN TERUGSPOELEN
- SCHNELLVORLAUF UND RÜCKLAUF
- FRAM- OCH ÅTERSPOLNING
- HURTIG FREMSPOLING
- AVVOLGIMENTO RAPIDO E RIAVVOLGIMENTO
- BOBINAGE RAPIDE ET REBOBINAGE
- OG TILBAGESPOLING

1

ff/cue

2

stop

1

rew/rev

2

stop

12

- "CUE" AND "REVIEW"
- "MEDHØR UNDER FREM-OG TILBAGESPOLING"
- "CUE" UND "REVIEW"
- "SONDAGE" AVANT ET "SONDAGE"
- "SEGNALIZZAZIONE" E "REVISIONE"
- MEELUISTEREN NE HERVATTEN

1

ff/cue

1

rew/rev

13

- REWIND/AUTOMATIC PLAYBACK
- OM "TILBAGESPOLING/AUTOMATISK AFSPILNING"
- ÅTERSPOLNING/AUTOMATISK AVSPELNING
- RÜCKLAUF/AUTOMATISCHE WIEDERGABE
- REBOBINAGE/LECTURE AUTOMATIQUE
- RIAVVOLGIMENTO/RIPRODUZIONE AUTOMATICA
- TERUGSPOELENEN AUTOMATISCHE WEERGAVE

1

rew/rev

2

play

2

play

14

• RECORDING
• INSPELNING

• ENREGISTREMENT
• OPNAME

• OPTAGELSE
• AUFNAHME

• REGISTRAZIONE

- Do not depress the Play button since this unit is set to the recording mode when only the Record button is depressed.
- Tryck inspelningknappen för att starta inspelning. (Avspelningsknappen behöver ej användas.)
- Ne pas enforcer le bouton de lecture étant donné que cet appareil n'est placé en mode d'enregistrement que par pression sur le bouton d'enregistrement.
- Druk de weergaveknop niet in aangezien het apparaat voor opnemen staat ingesteld als de opnameknop is ingedrukt.

- Tryk ikke afspilningsknappen ned, da dette apparat er indstillet til optagelse, når kun indspilningsknappen er nedtrykket.
- Bei diesem Gerät braucht zur Aufnahme nur die Aufnahmetaste gedrückt werden. Die Wiedergabetaste also bitte nicht drücken.
- Non abbassare il tasto di riproduzione in quanto apparecchio si regola per la funzione di registrazione abbassando soltanto il tasto di registrazione.

1

power push on

2

- Refer to fig. 9-12.
- Se fig. 9-12.
- Se reporter à fig. 9-12.
- Zie fig. 9-12.
- Se fig. 9-12.
- Siehe Abb. 9-12.
- Rif. fig. 9-12.

3

tape select
Nor. Fe-Cr CrO₂ Metal

- Refer to fig. 7.
- Se fig. 7.
- Se reporter à fig. 7.
- Zie fig. 7.
- Se fig. 7.
- Siehe Abb. 7.
- Rif. fig. 7.

4

Noise Reduction
Dolby NR out tape disc

- See to page E-2, 3.
- Se sid SV-2, 3.
- Voir page F-2, 3, 4.
- Zie naar blad N-2, 3, 4.
- Se side D-2, 3.
- Siehe Seite D-2, 3, 4.
- Ved. pag. I-2, 3.

5

input select
line mic

line

LINE IN

REC OUT

5

input select
line mic

mic

(left) (right)

6

② ○ rec

① || pause

7

input level
L R

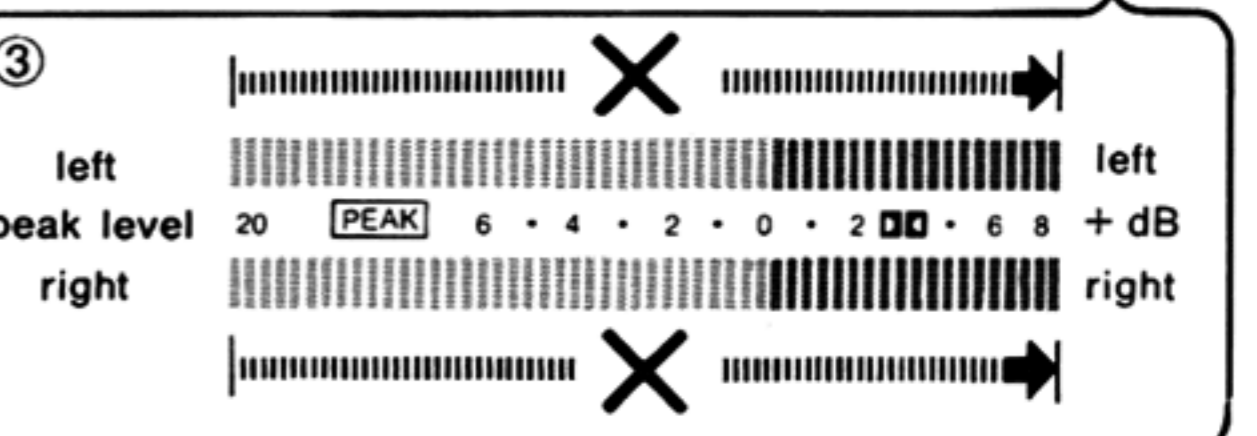
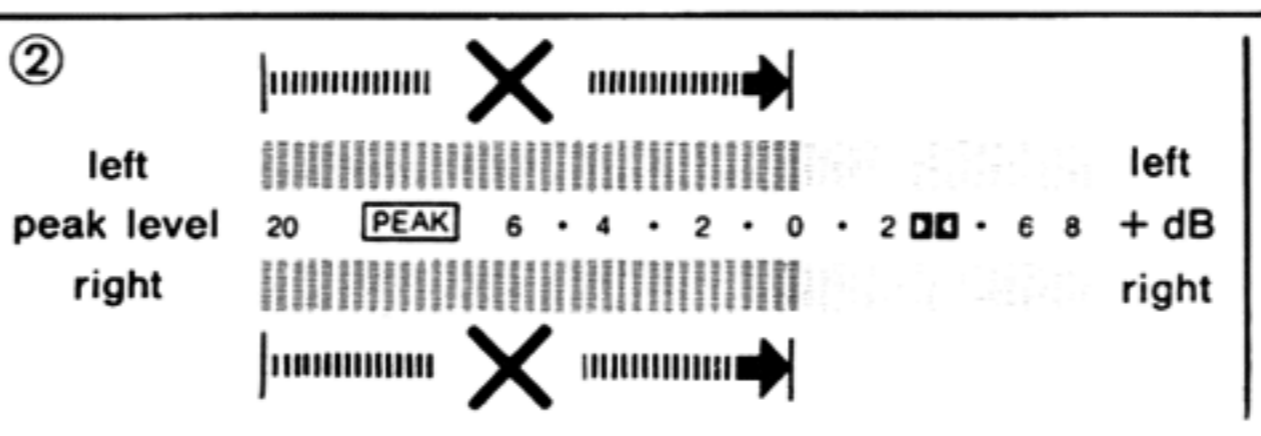
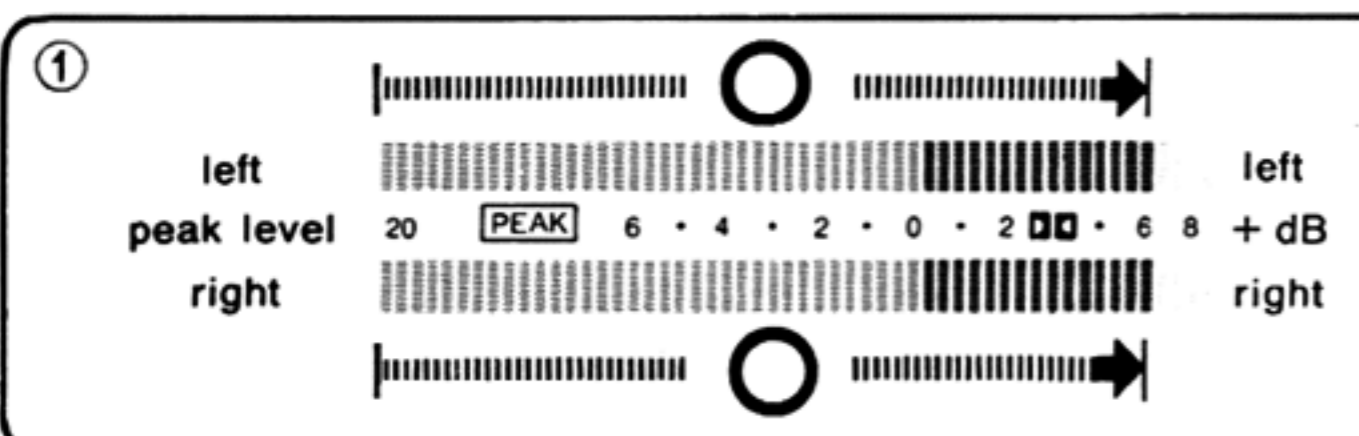

8

tape counter

9

|| pause

10

■ stop

- Connections to the power source
- Nätanslutning
- Branchements a l'alimentation
- Aansluitingen aan het voedings net
- Tilslutningsmuligheder på strøm for syning
- Anschluß ans Netz
- Connessioni alla sorgente elettrica

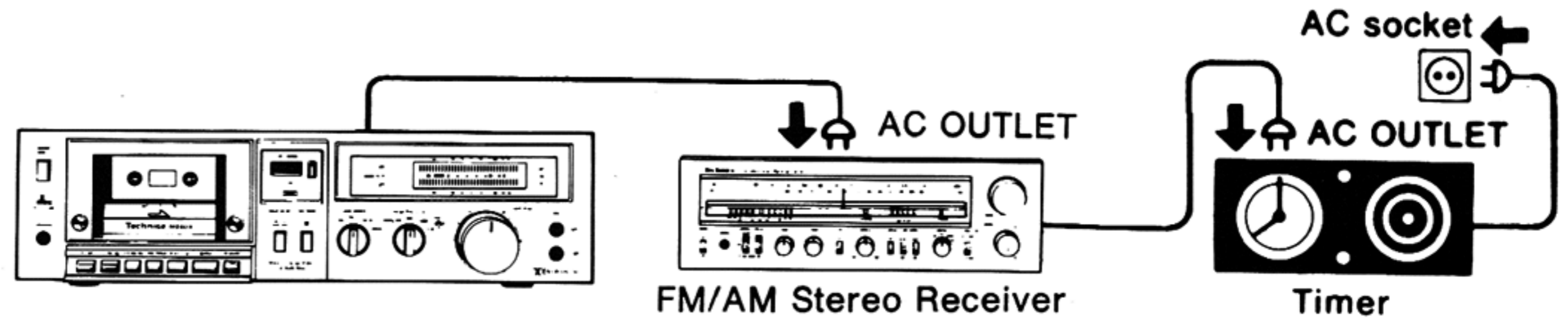

- Mode selection for timer (recording or playback) should be made after the power is completely turned "OFF".
- If a timer mode selection change is desired (from recording to playback or viceversa), please make new selection starting from step No. 1 of the new mode as per instructions.
- Do not make timer mode selection changes with the power "OFF" otherwise when the timer turns the unit on, there is a possibility that the wrong mode selection will be activated.
- Do not select the mode while turning the power "OFF".

- Strömmen måste vara franslagen till "OFF" med tiduret, innan däckat göres klart för in-eller avspelning med tidur.
- Om redan gjord inställning måste ändras från t. ex inspelning till avspelning, förfar enligt anvisningarna med början från steg 1.
- Ändra ej från in-till avspelning (eller tvärtom) med strömbrytaren på "OFF" fel funktion kan komma att kopplas in.
- Vänta några sekunder med inställningen efter frånslag till "OFF".

- Le choix du mode d'utilisation de la minuterie (enregistrement ou lecture) doit être effectué après que le courant électrique est coupé (OFF) complètement.
- Si l'on souhaite modifier le mode d'utilisation de la minuterie (c.à.d. de l'enregistrement à la lecture, ou vice-versa), prière de déterminer ce nouveau mode en commençant au point 1 de celui-ci, comme énoncé dans les explications.
- Ne pas effectuer de changement du mode d'utilisation de la minuterie quand le courant électrique est coupé (OFF), car la minuterie risque de ne pas fonctionner selon le mode voulu lorsqu'elle est placée sous tension.
- Ne pas choisir le mode d'utilisation de la minuterie au moment même où l'on coupe (OFF) son alimentation électrique.

- Het kiezen van de schakelklokkfunctie (opnemen of weergeven) dient te worden gedaan nadat de stroom is uitgeschakeld (OFF).
- Bij het veranderen van de schakelklokkfunctie (van opnemen naar weergeven of vice versa) dienen de bedieningsaanwijzingen opnieuw te worden opgevolgd vanaf stap Nr. 1, zoals beschreven in de gebruiksaanwijzing.

- Verander de schakelklokkfunctie niet terwijl het apparaat uitgeschakeld staat (OFF), aangezien het anders mogelijk is dat de verkeerde functie wordt geactiveerd als het apparaat wordt ingeschakeld door de schakelklok.
- Kies de functie niet bij het uitschakelen van het apparaat (OFF).

- Funktionsindstilling for brug med kontaktur (timer) til ind-eller afspilning kan kun foretages, når apparatet er afbrudt ("OFF").
- Når De ønsker at ændre apparatets indstilling for kontaktur (fra indspilning til afspilning eller omvendt), skal De foretage den nye indstilling ved at gå frem fra trin 1 i vejledningen for den pågældende indstilling.
- Forsøg ikke at ændre indstillingen for kontaktur, mens apparatet er afbrudt. Ellers vil der være en mulighed for, at den forkerte indstilling bliver sat i gang, når kontakturet tænder for apparatet.
- Vælg ikke den ønskede indstilling, mens De afbryder apparatet.

- Betriebsartenwahl für Timer (Aufnahme oder Wiedergabe) ist erst vorzunehmen, nachdem der Strom vollständig ausgeschaltet ist (OFF).
- Wenn der Timer-Betrieb umgeschaltet werden soll (von Aufnahme auf Wiedergabe und umgekehrt), zur Neuwahl mit Schritt Nr. 1 der neuen Betriebsart gemäß Anleitung beginnen.
- Keine Timer-Betriebsartenwähländerungen bei ausgeschaltetem Strom vornehmen, da sonst die Möglichkeit besteht, daß die falsche Betriebsartenwahl aktiviert wird, wenn der Timer das Gerät einschaltet.
- Die Betriebsart nicht wählen, während der Strom ausgeschaltet wird (OFF).

- Il modo di selezione del timer (registrazione e riproduzione) dovrebbe essere effettuato dopo aver spento completamente l'apparecchio;
- Se si desidera cambiare il modo di selezione del timer (da registrazione a riproduzione o viceversa), effettuare la nuova selezione cominciando dall'operazione del punto 1 del nuovo modo come indicato precedentemente.
- Non si devono effettuare i cambiamenti di modo del timer con l'apparecchio spento, altrimenti quando il timer accende l'apparecchio si potrebbe attivare il modo sbagliato di selezione.
- Non si deve selezionare il modo mentre si spegne l'apparecchio.

- **Playback with a timer**
- **Avspelning med tidur**
- **Lecture avec minuterie**

- **Terug spelen met behulp van een tijd klok**
- **Afspilning med kontaktur**

- **Wiedergabe mit einem Zeitschalter**
- **Riproduzione col "timer"**

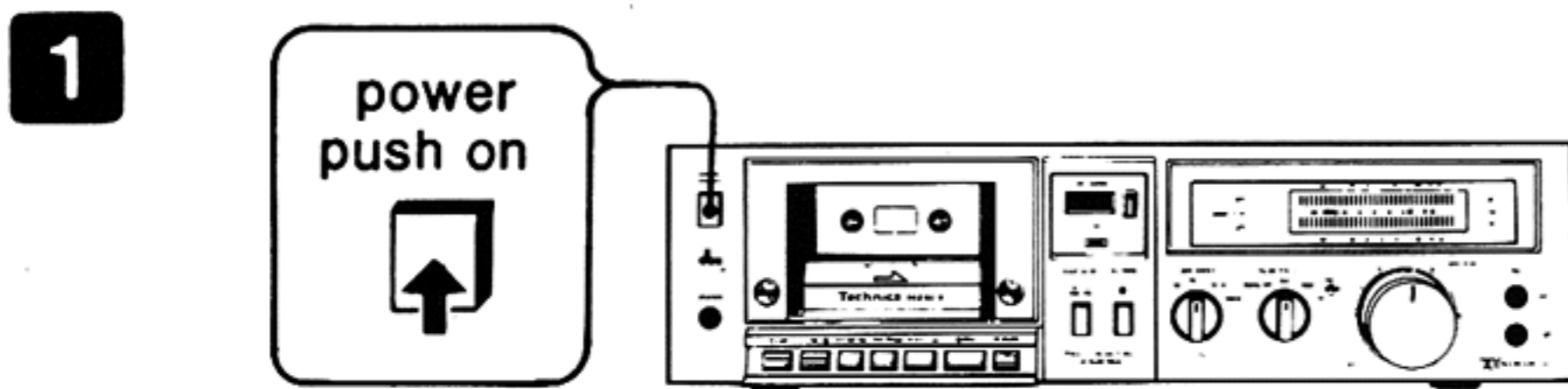

- 2**
- Refer to fig. 9-12.
 - Se fig. 9-12.
 - Se reporter à fig. 9-12.
 - Zie fig. 9-12.
 - Se fig. 9.-12.
 - Siehe Abb. 9-12.
 - Rif. fig. 9-12.

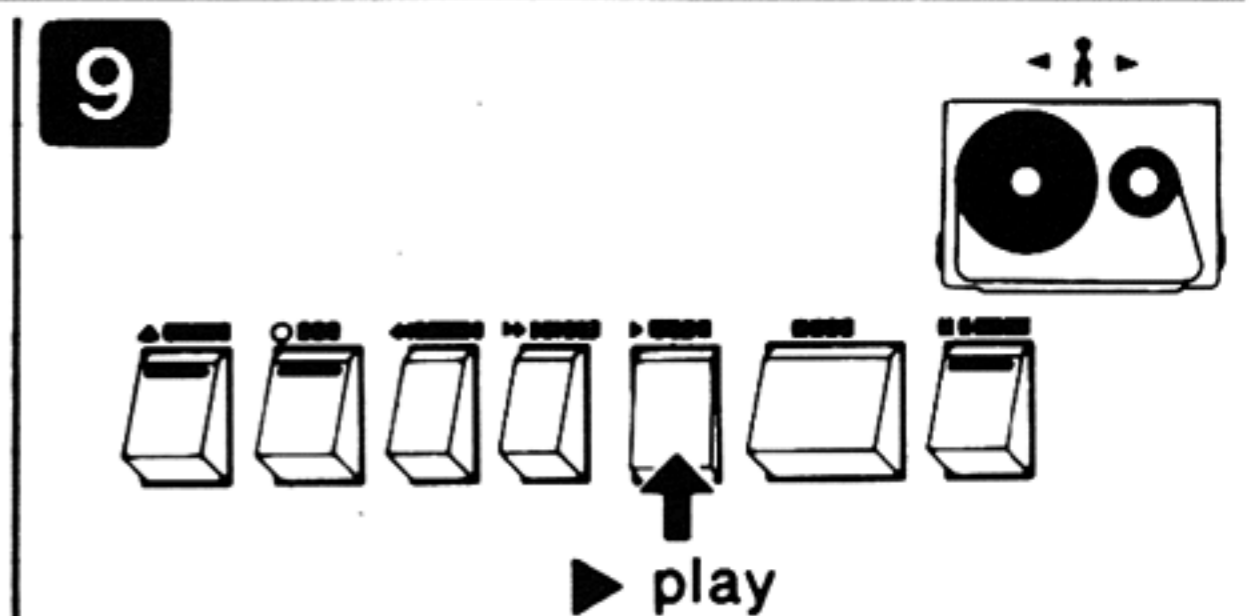
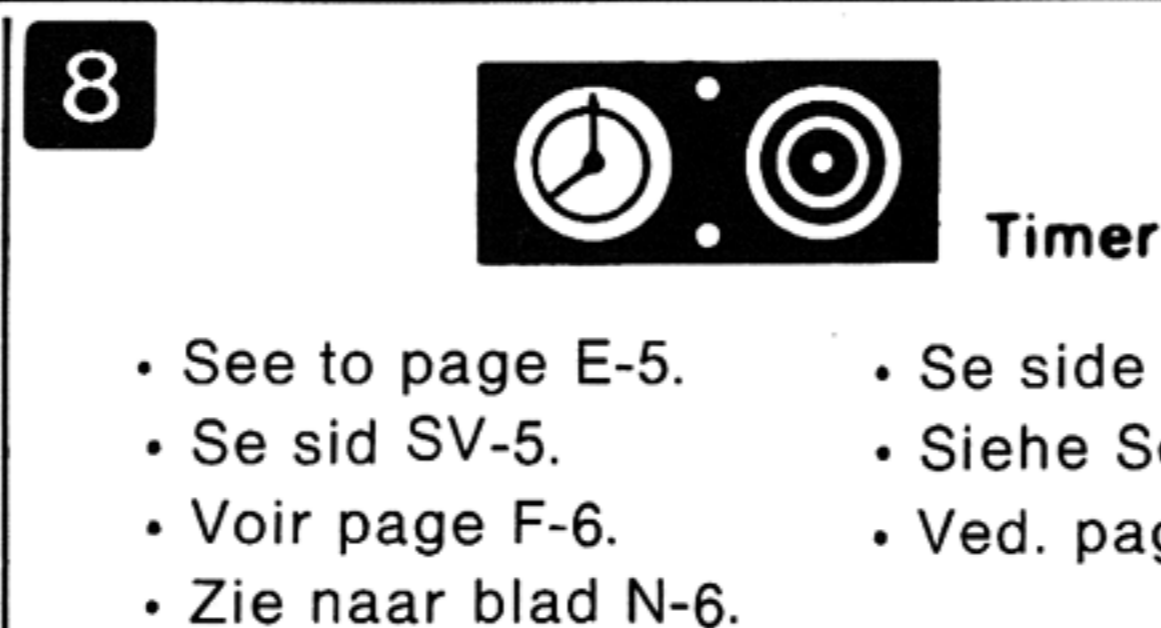
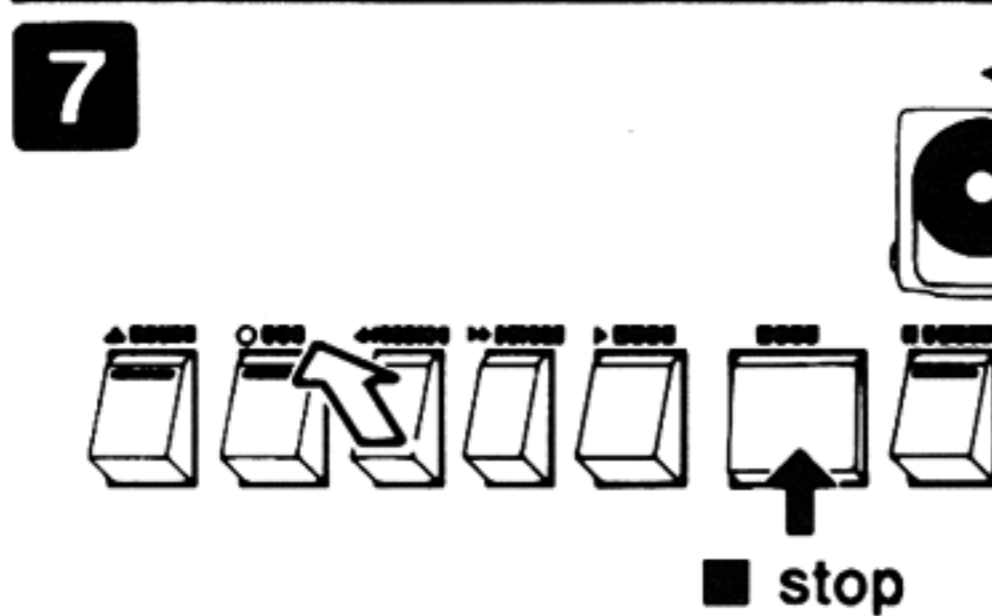
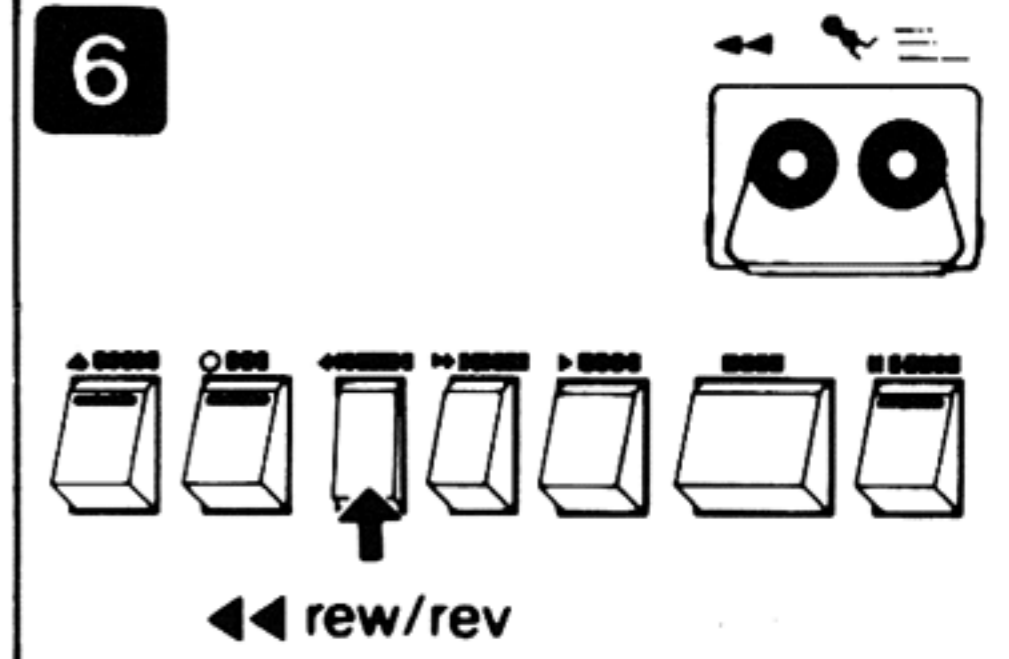
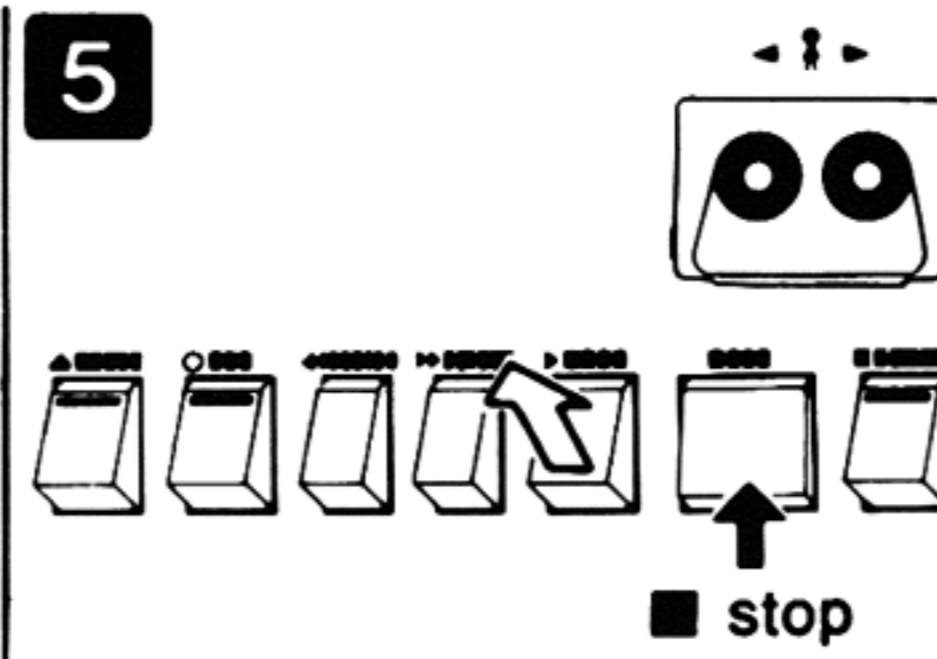
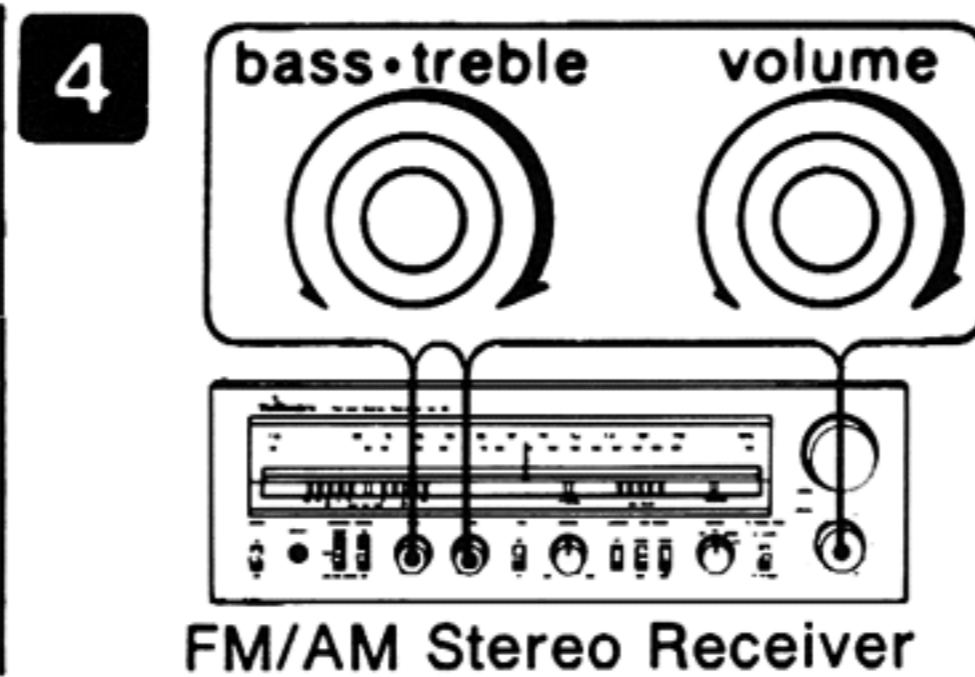
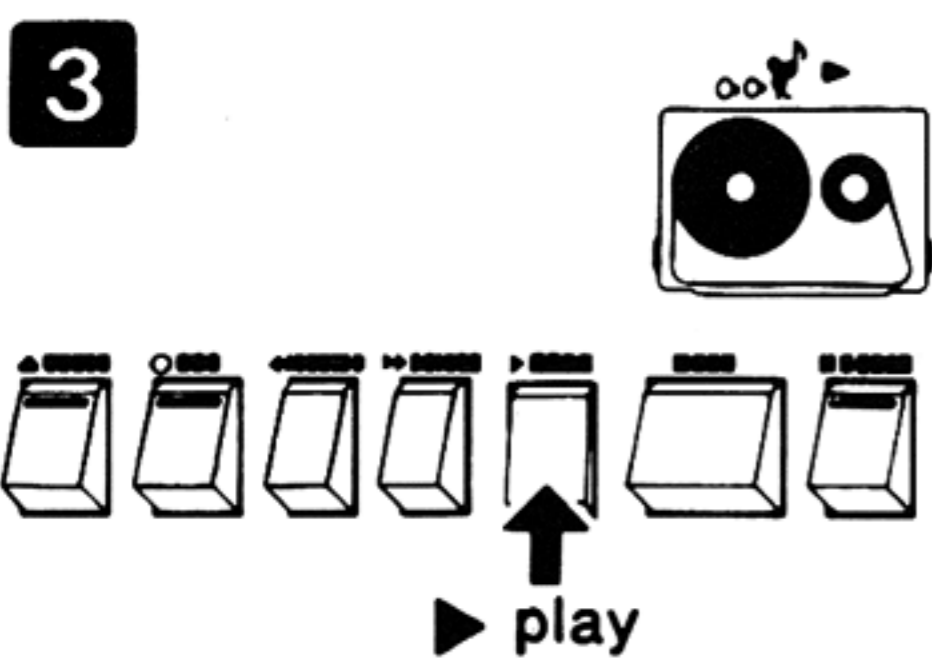

- See to page E-5.
- Se sid SV-5.
- Voir page F-6.
- Zie naar blad N-6.

- Se side D-5.
- Siehe Seite D-6.
- Ved. pag. I-5.

- Recording with a timer
- Inspeling met tidur
- Enregistrement avec minuterie

- Opname met een tijd klok
- Indspilning med kontaktur

- Aufnahme mit einem zeitschalter
- Registrazione col "timer"

1

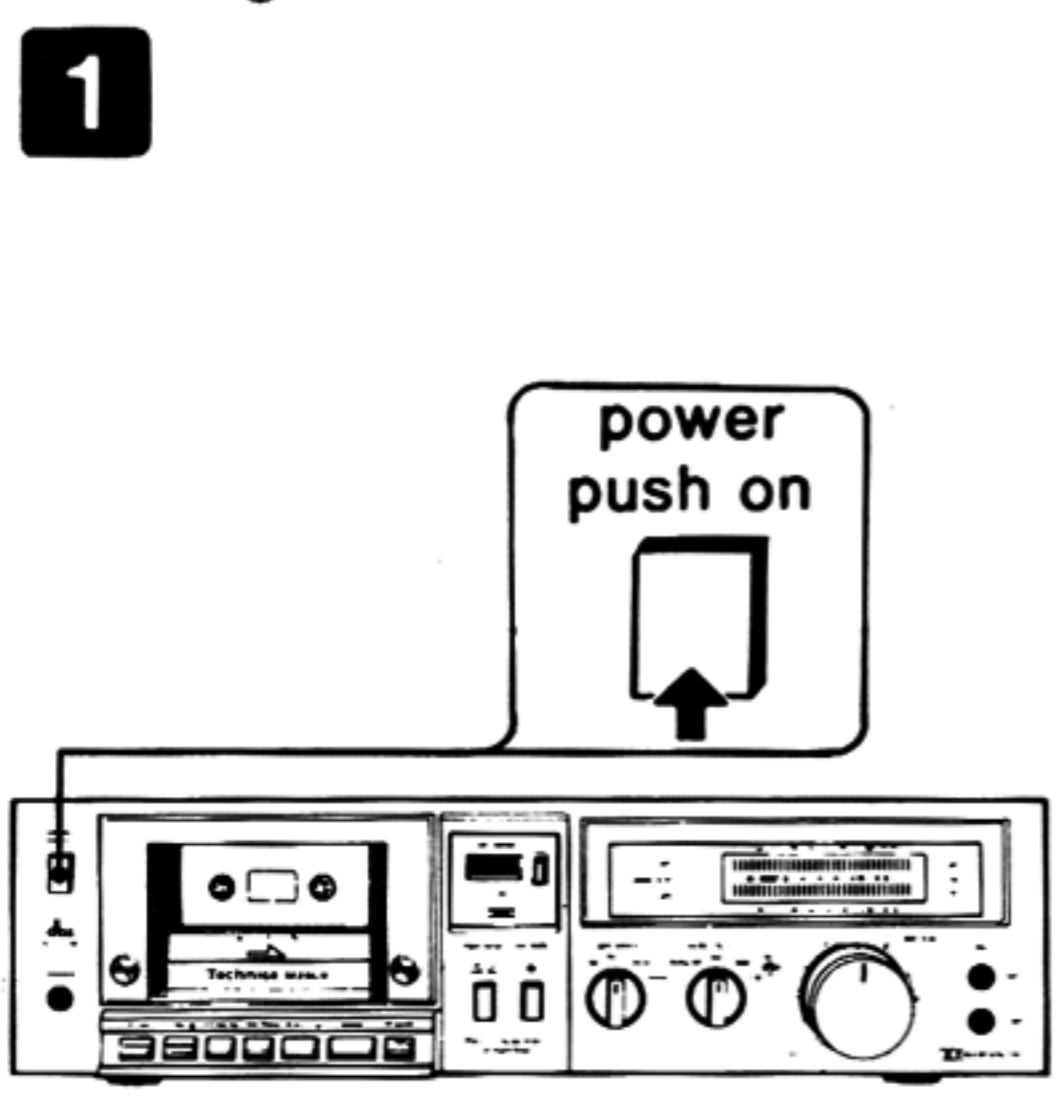

power push on

2

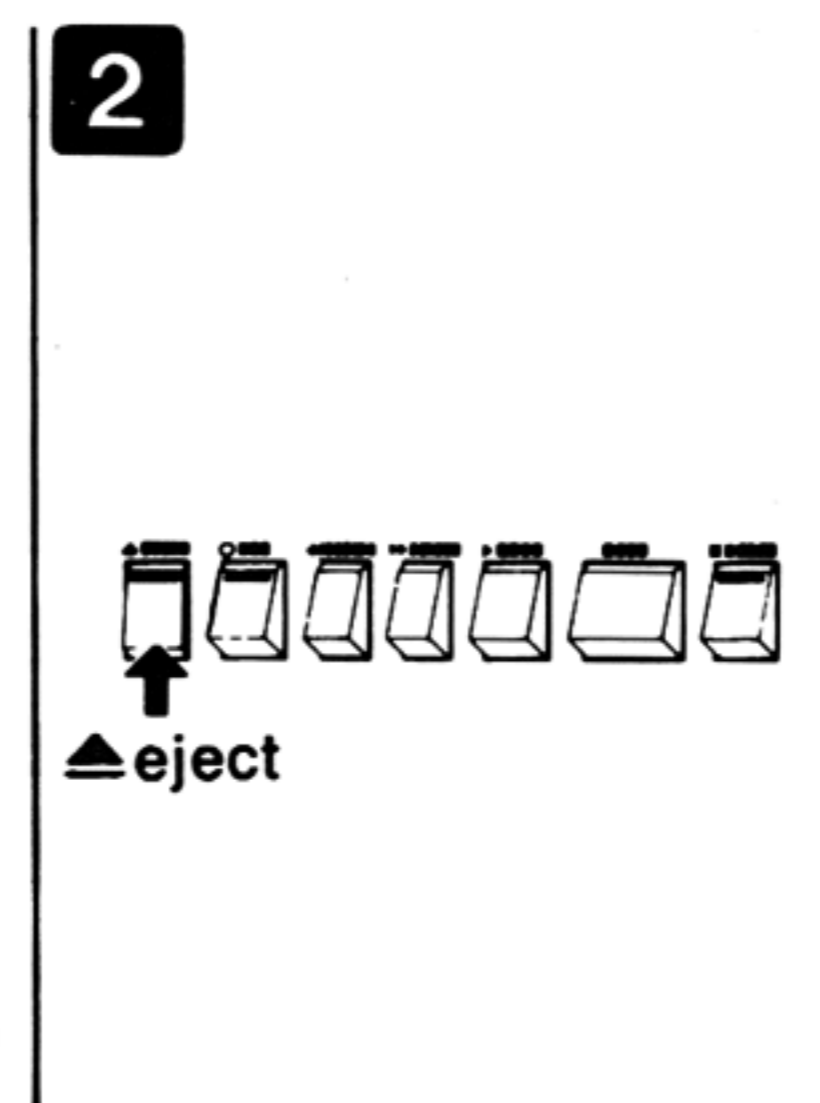

eject

3

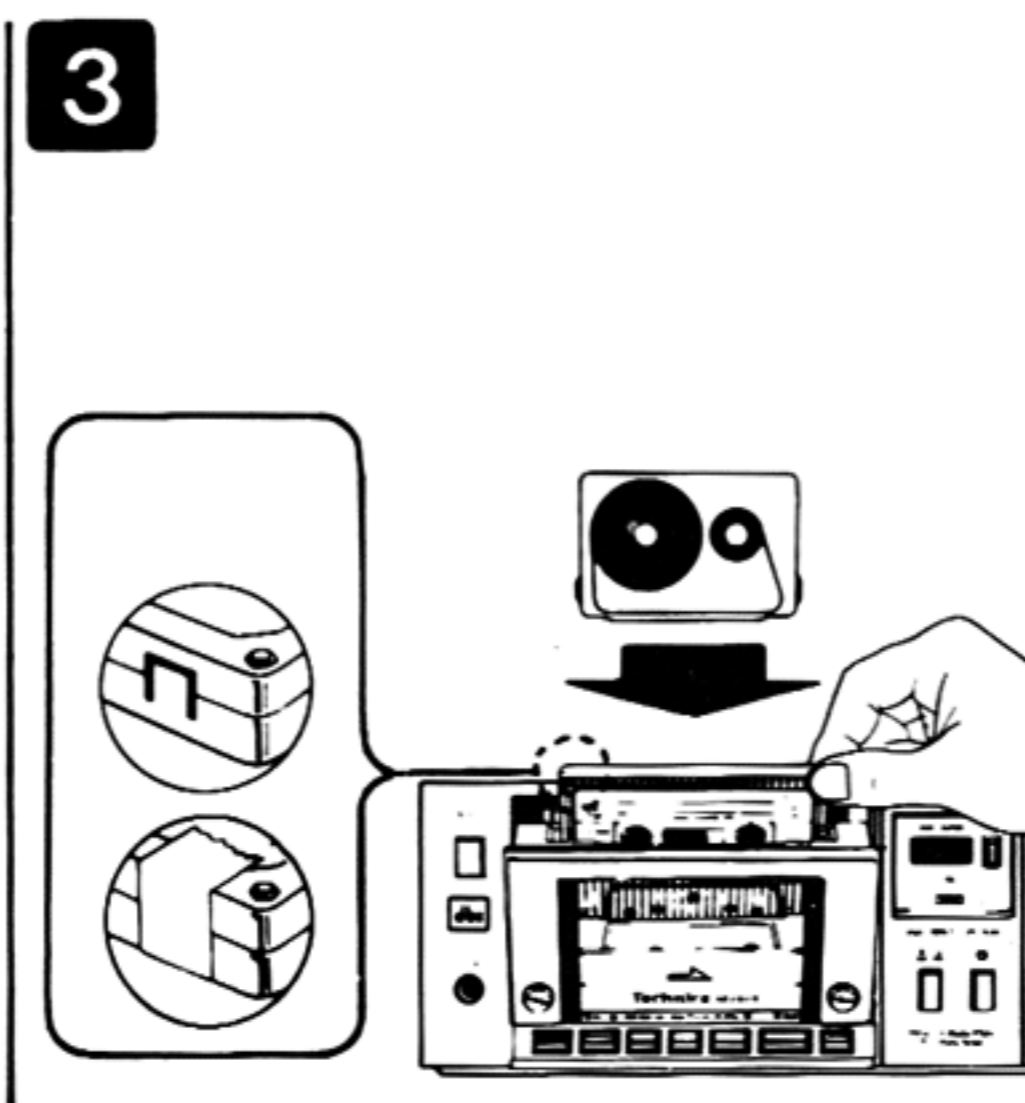

4

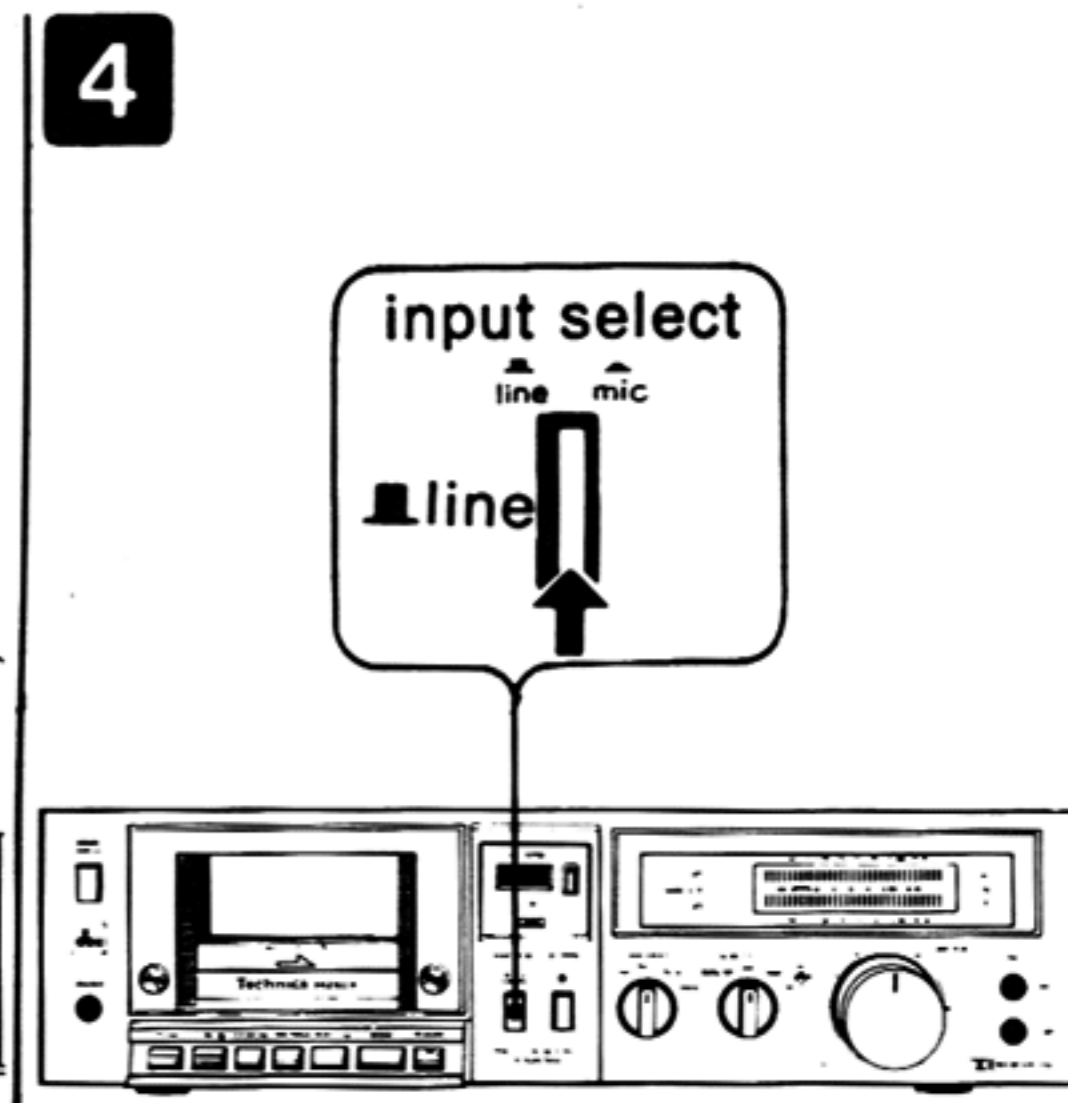

input select
line mic
line

5



Tuning

FM/AM Stereo Receiver

6

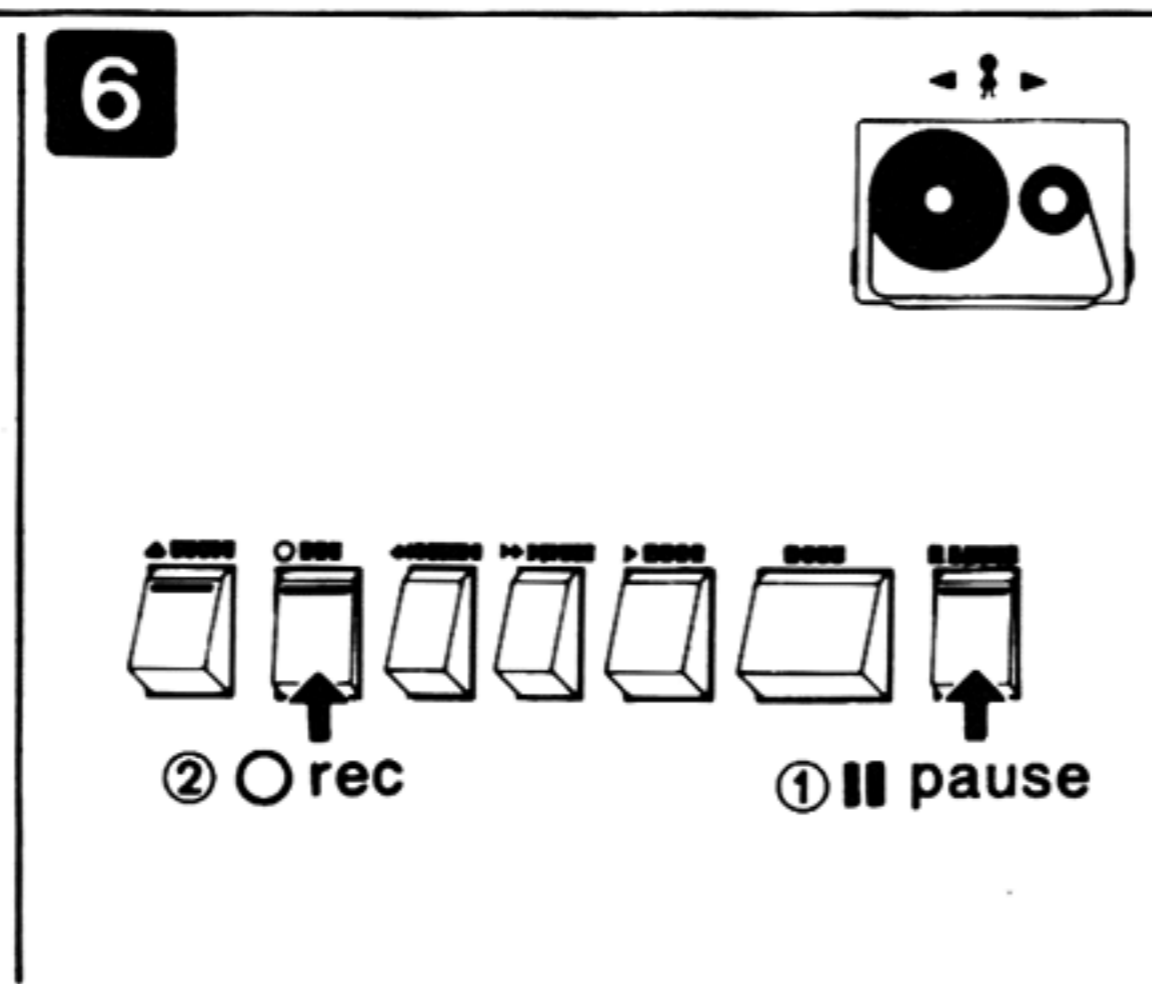

rec pause

7

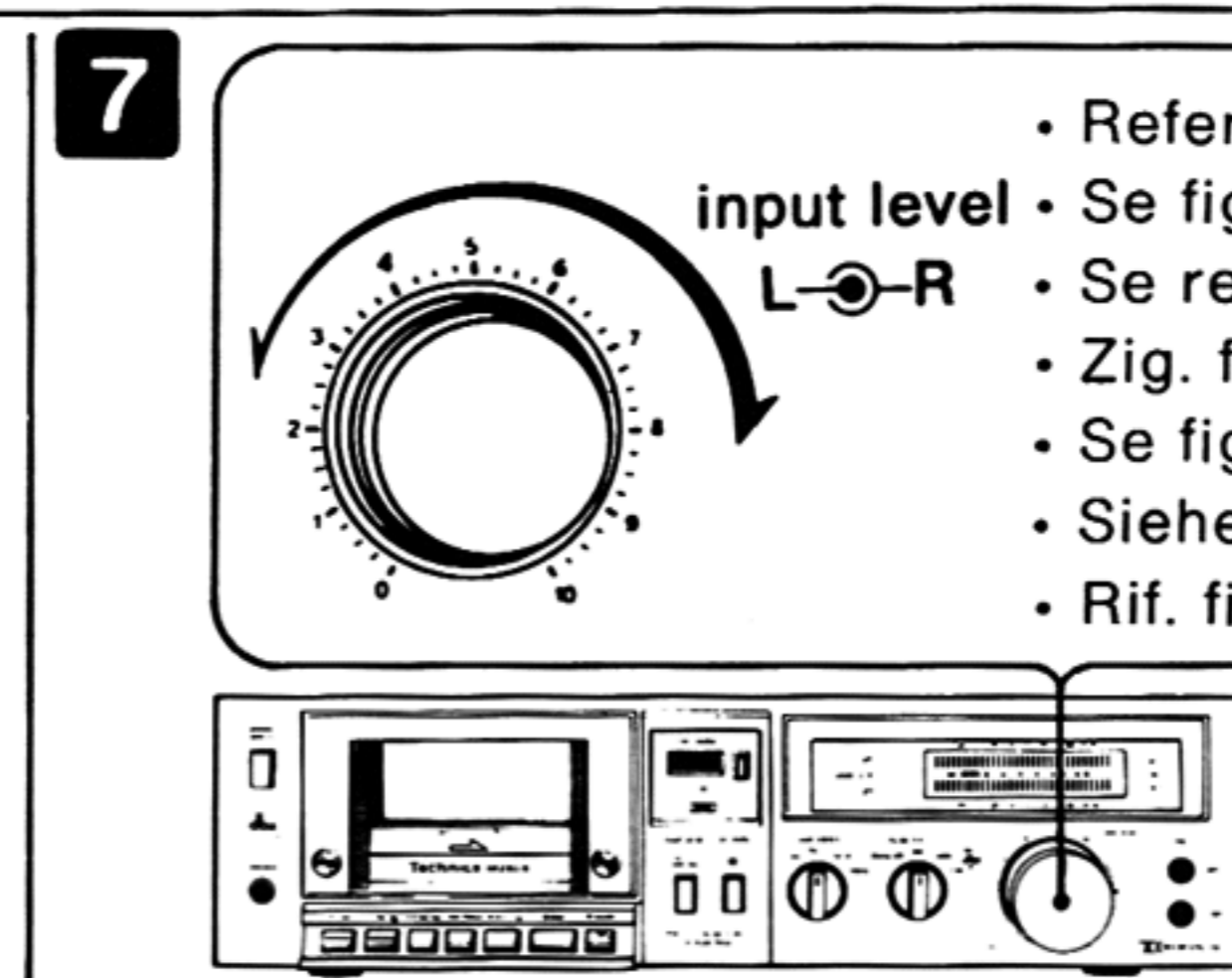

input level L-R

- Refer to fig. 14-7.
- Se fig. 14-7.
- Se reporter à fig. 1-4-7.
- Zig. fig. 14-7.
- Se fig. 14-7.
- Siehe Abb. 14-7.
- Rif. fig. 14-7.

8

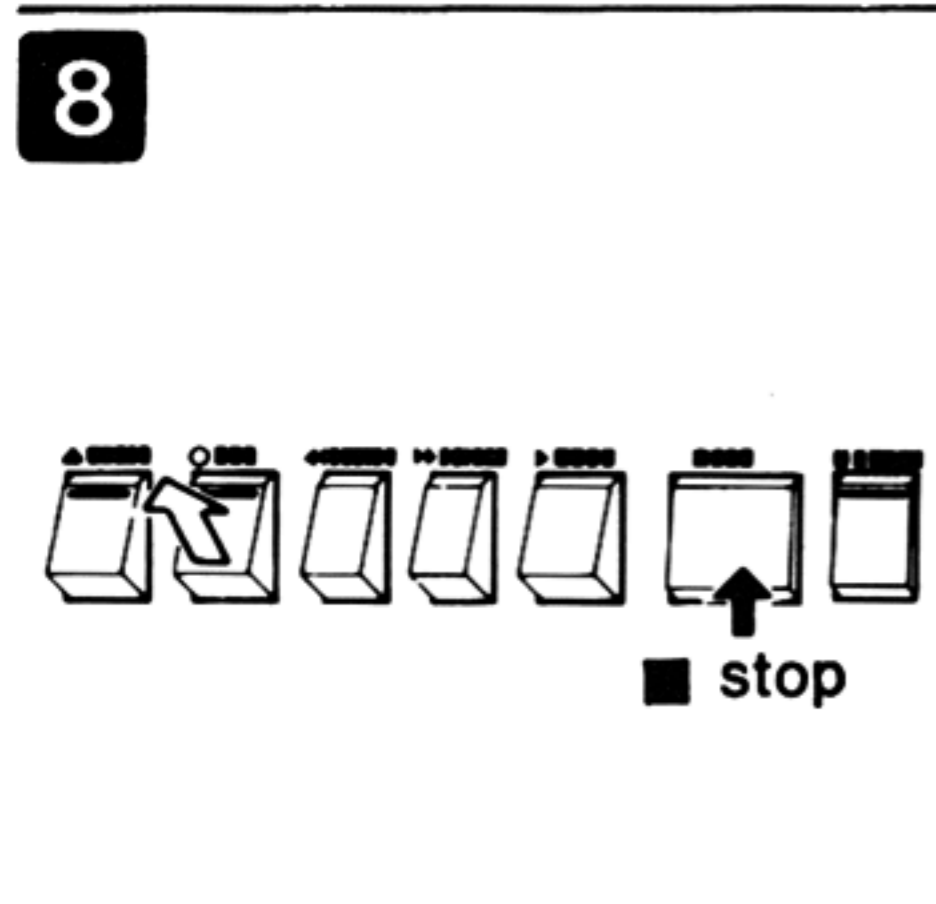

stop

9

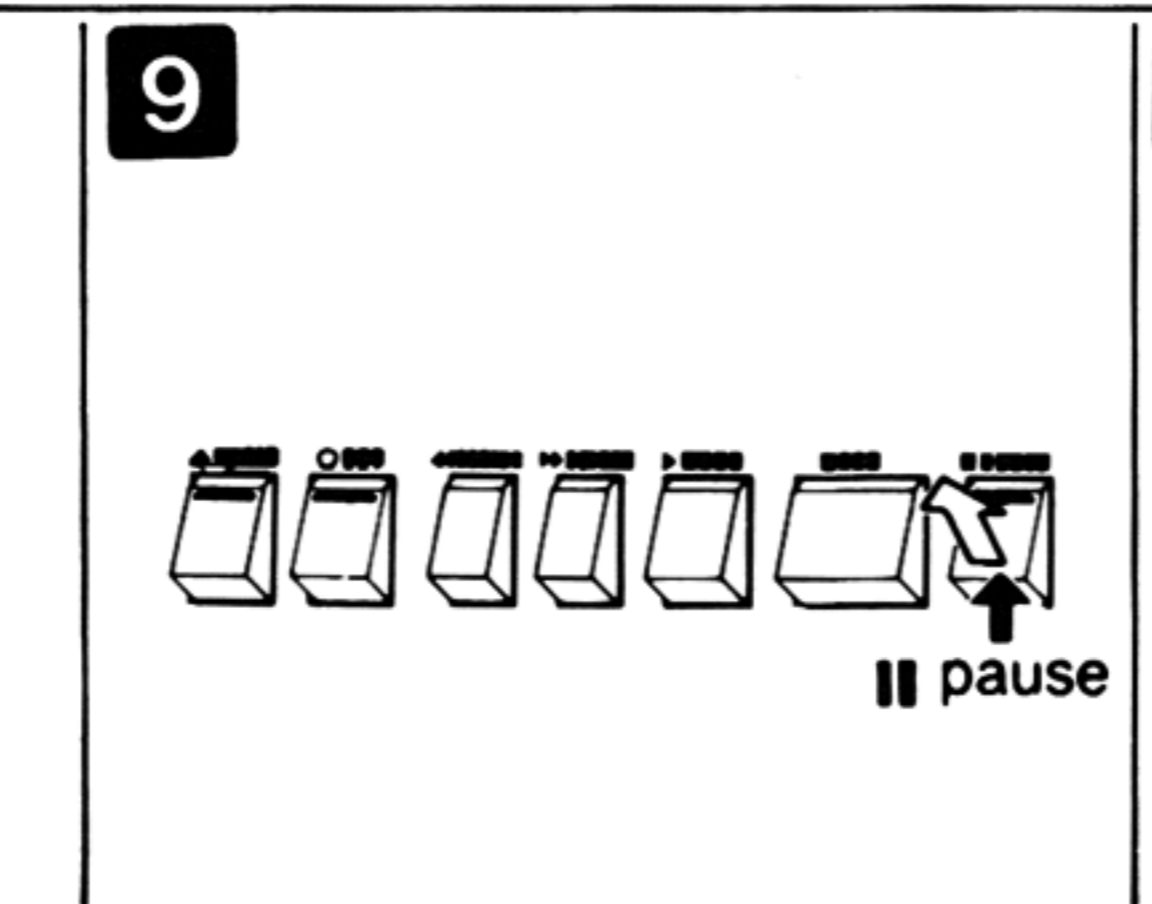

pause

10



Timer

- See to page E-5.
- Se sid SV-5.
- Voir page F-6.
- Zie naar blad N-6.
- Se side D-5.
- Siehe Seite D-6.
- Ved. pag. I-5.

11

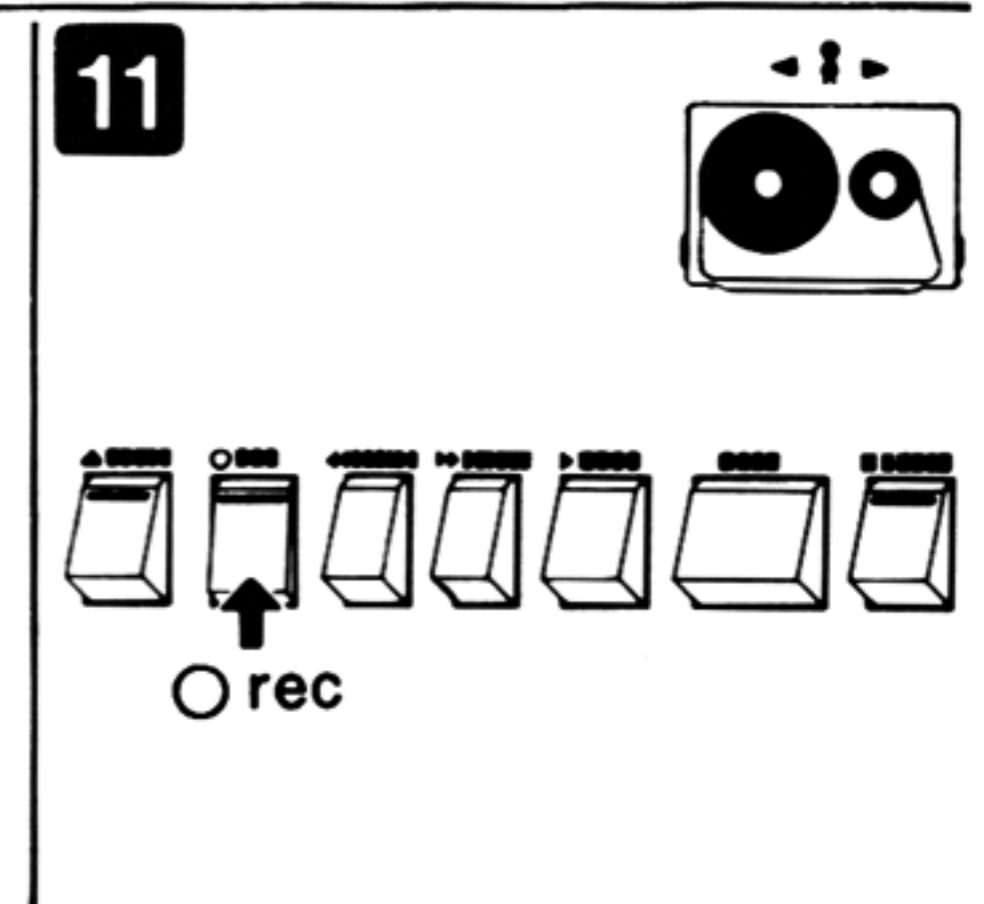

rec

16

- ERASING
- RADERING
- EFFACEMENT
- WISSEN
- SLETNING
- LÖSCHEN
- CANCELLATURA (del nastro)

1

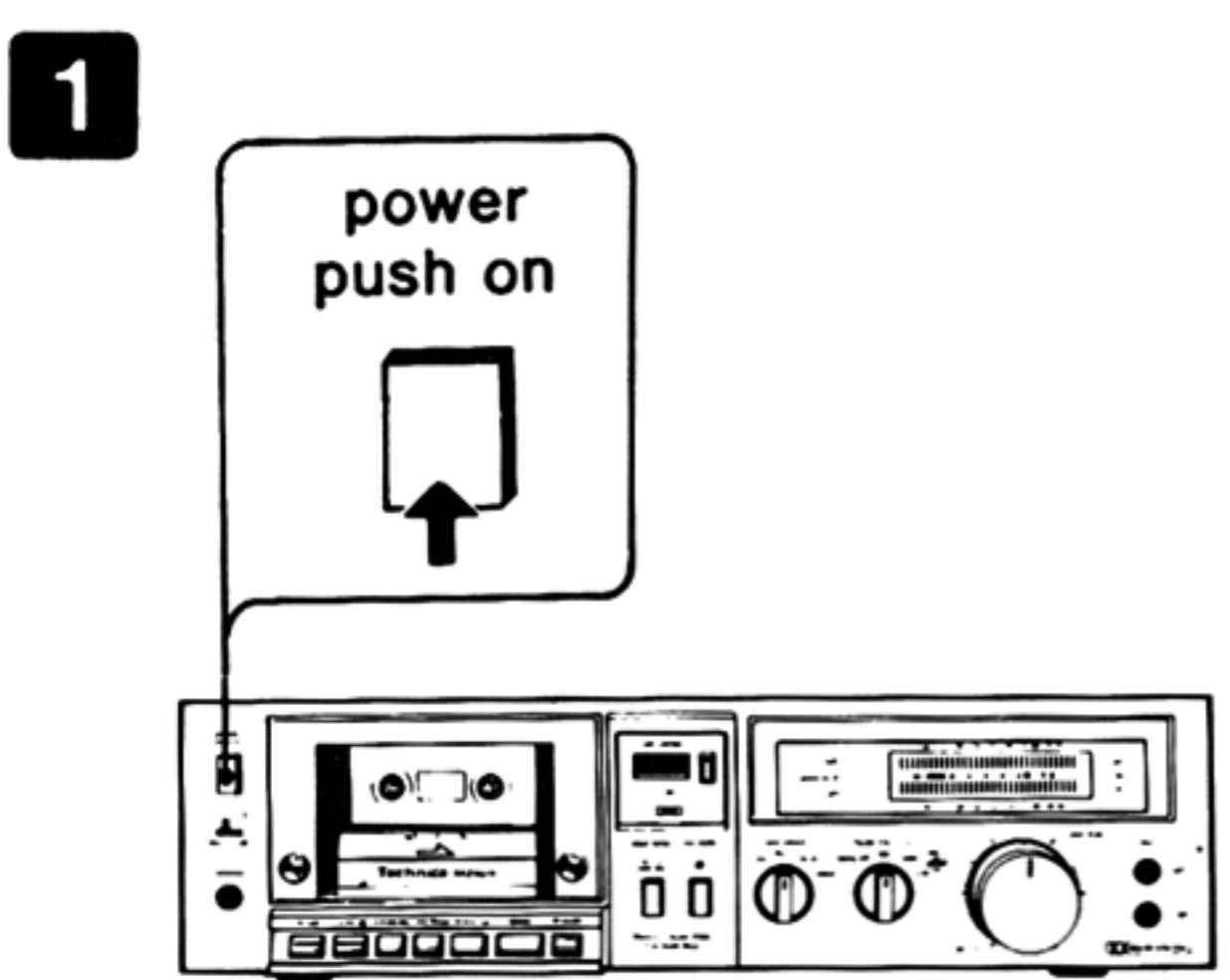

power push on

2

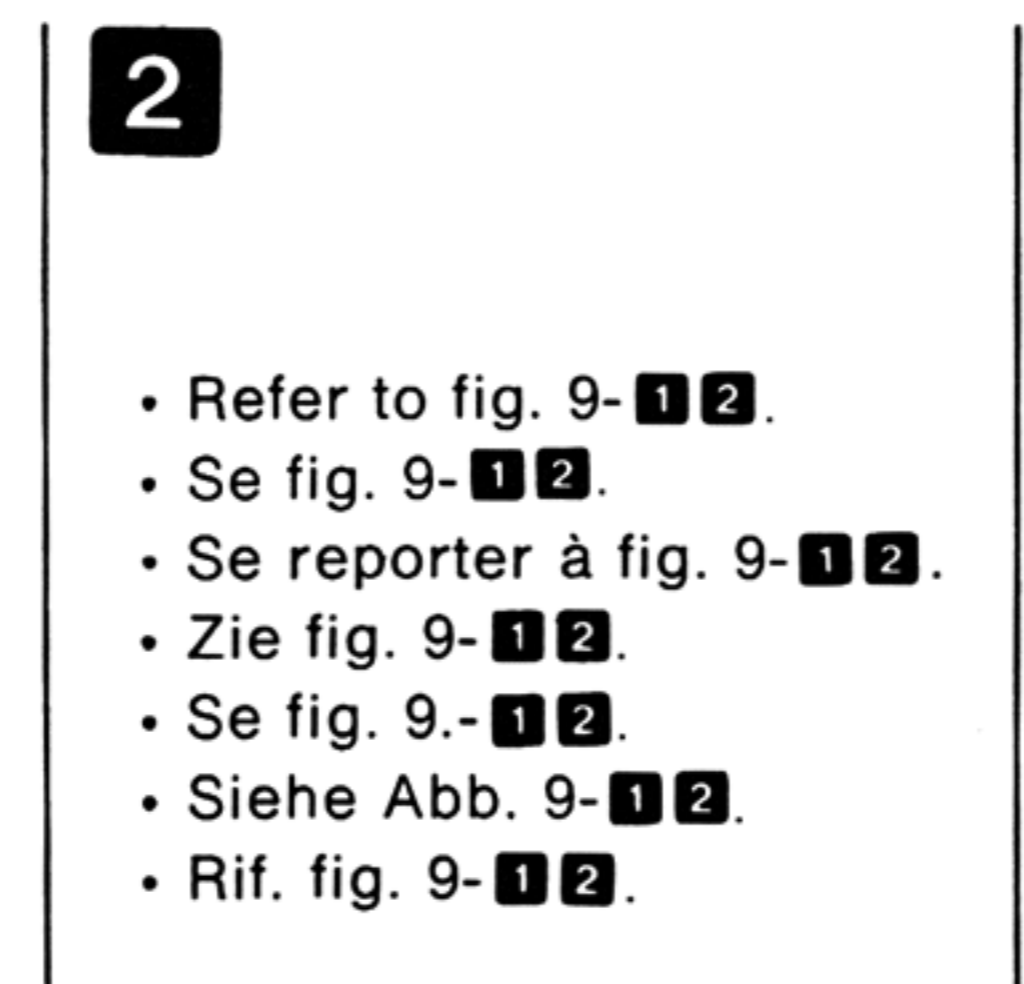

rec pause

- Refer to fig. 9-12.
- Se fig. 9-12.
- Se reporter à fig. 9-12.
- Zie fig. 9-12.
- Se fig. 9-12.
- Siehe Abb. 9-12.
- Rif. fig. 9-12.

3

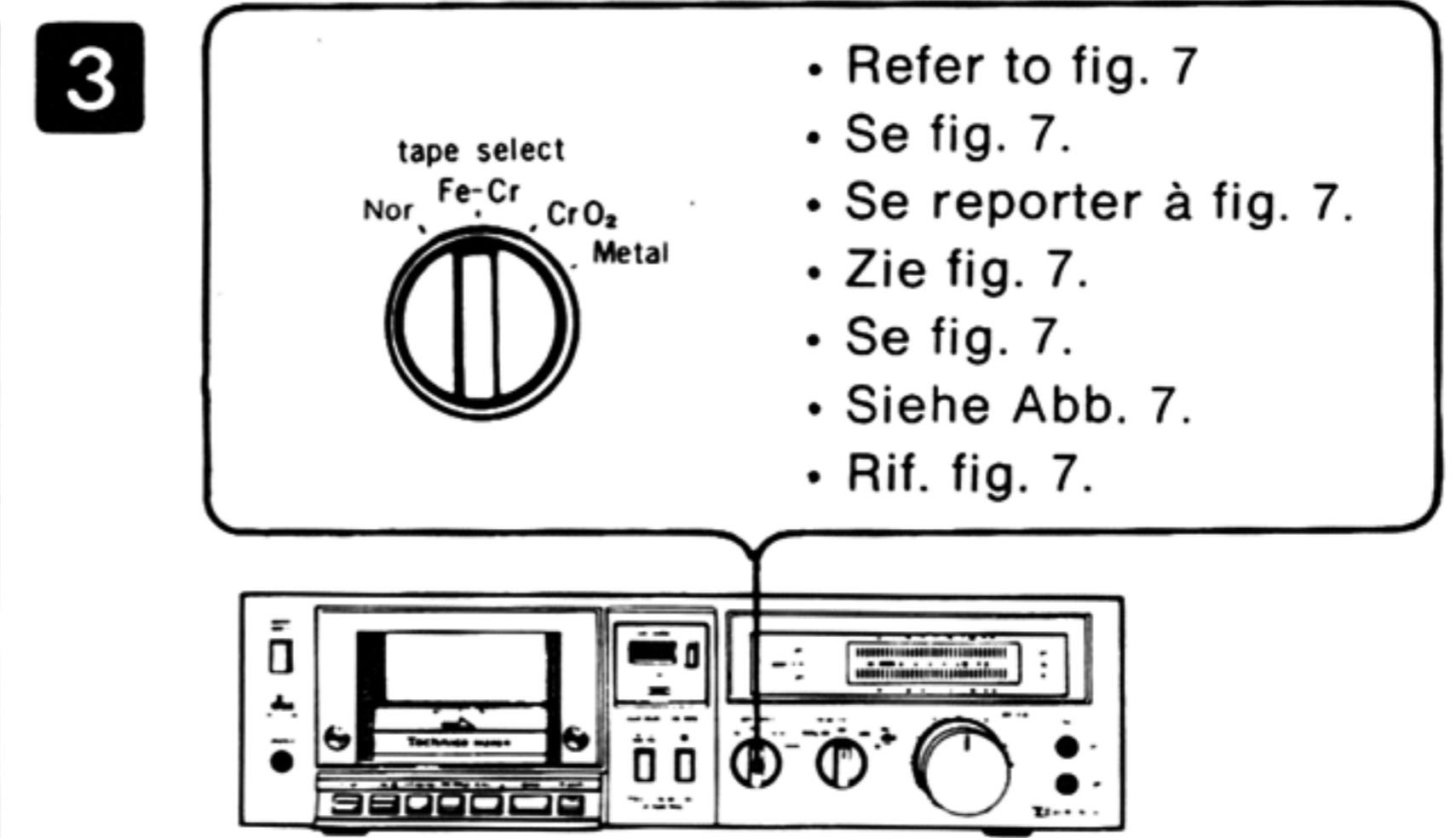

tape select
Nor Fe-Cr CrO₂ Metal

- Refer to fig. 7
- Se fig. 7.
- Se reporter à fig. 7.
- Zie fig. 7.
- Se fig. 7.
- Siehe Abb. 7.
- Rif. fig. 7.

4

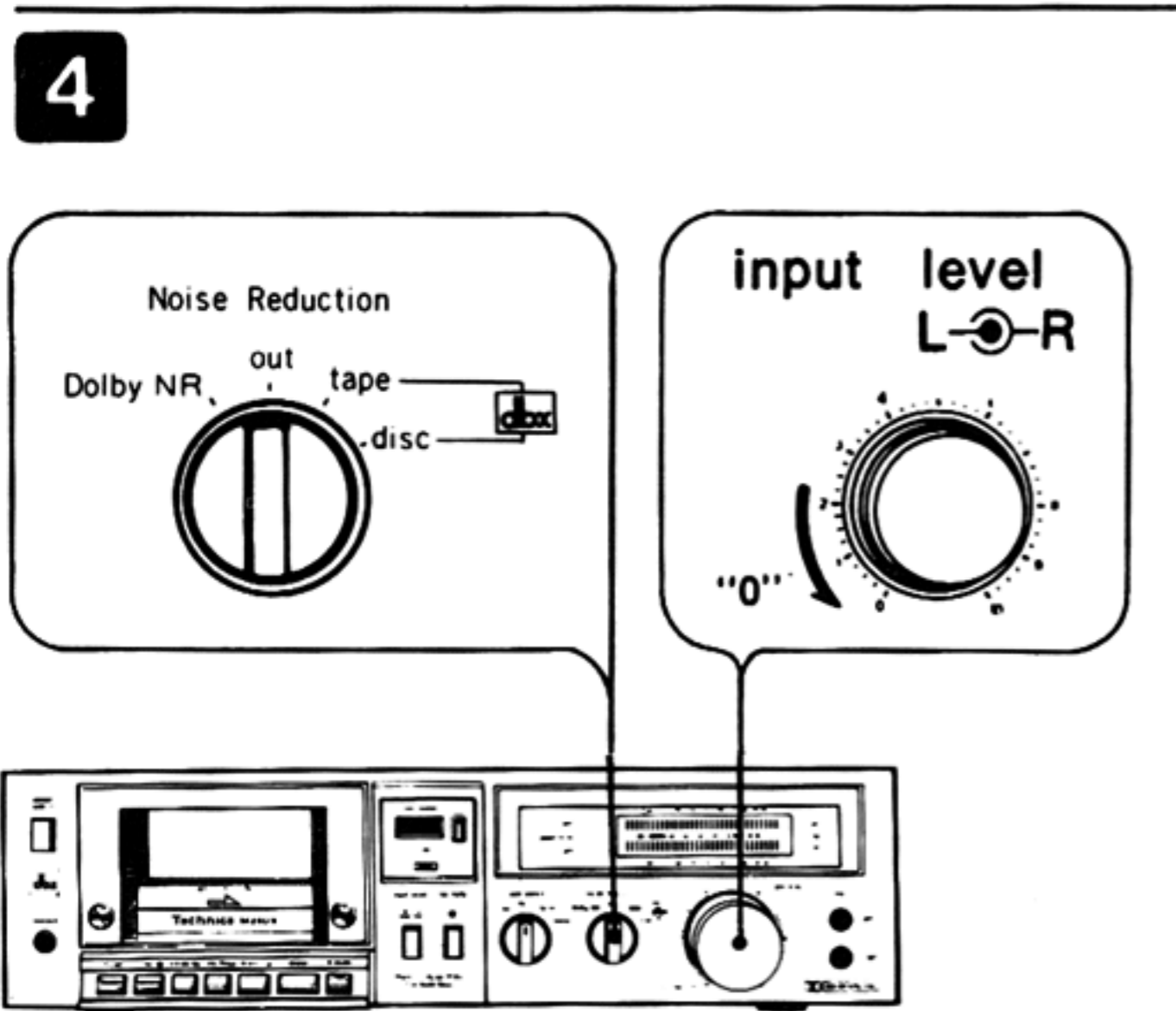

Noise Reduction
Dolby NR out tape disc

input level L-R

5

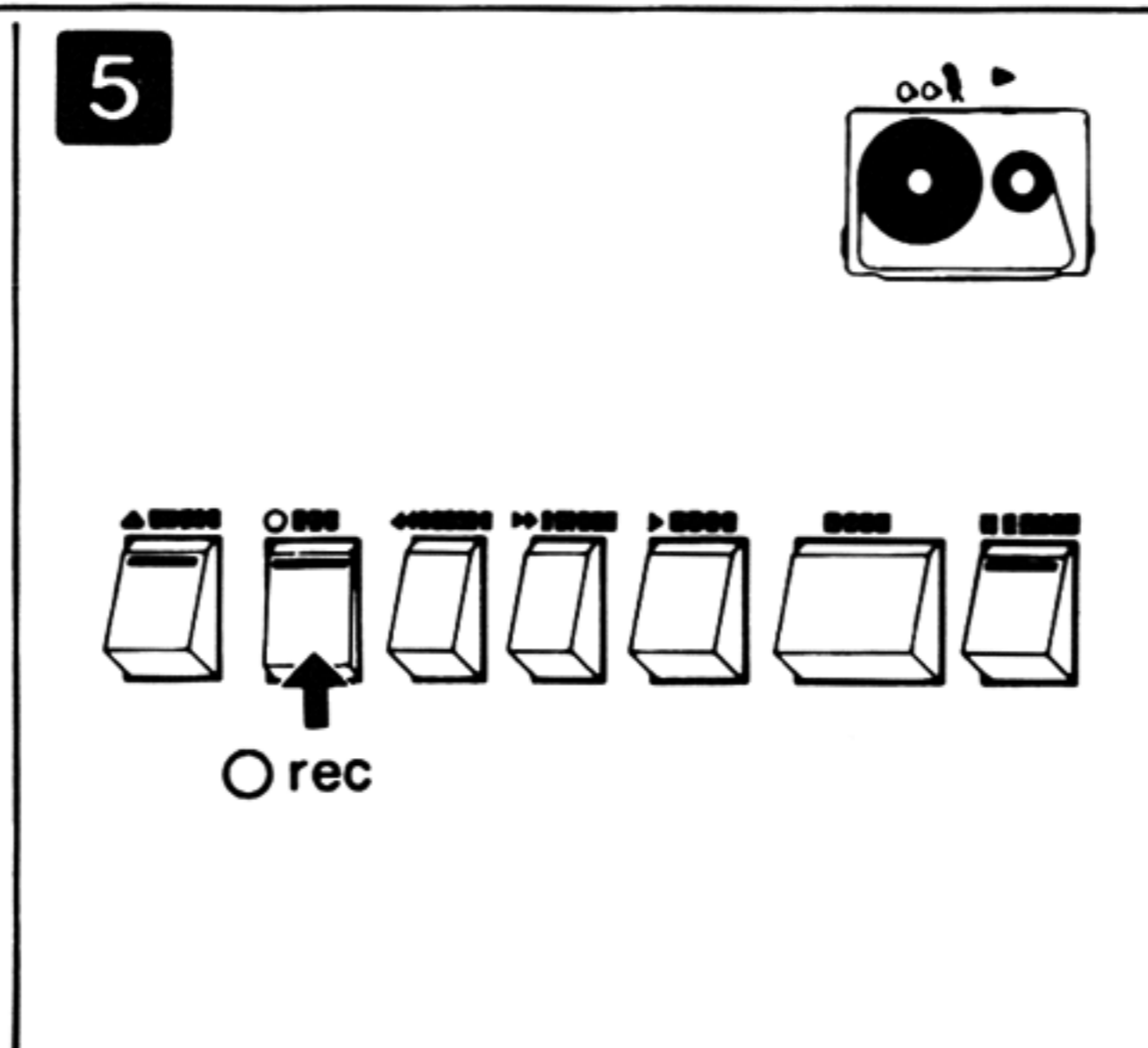

rec

6

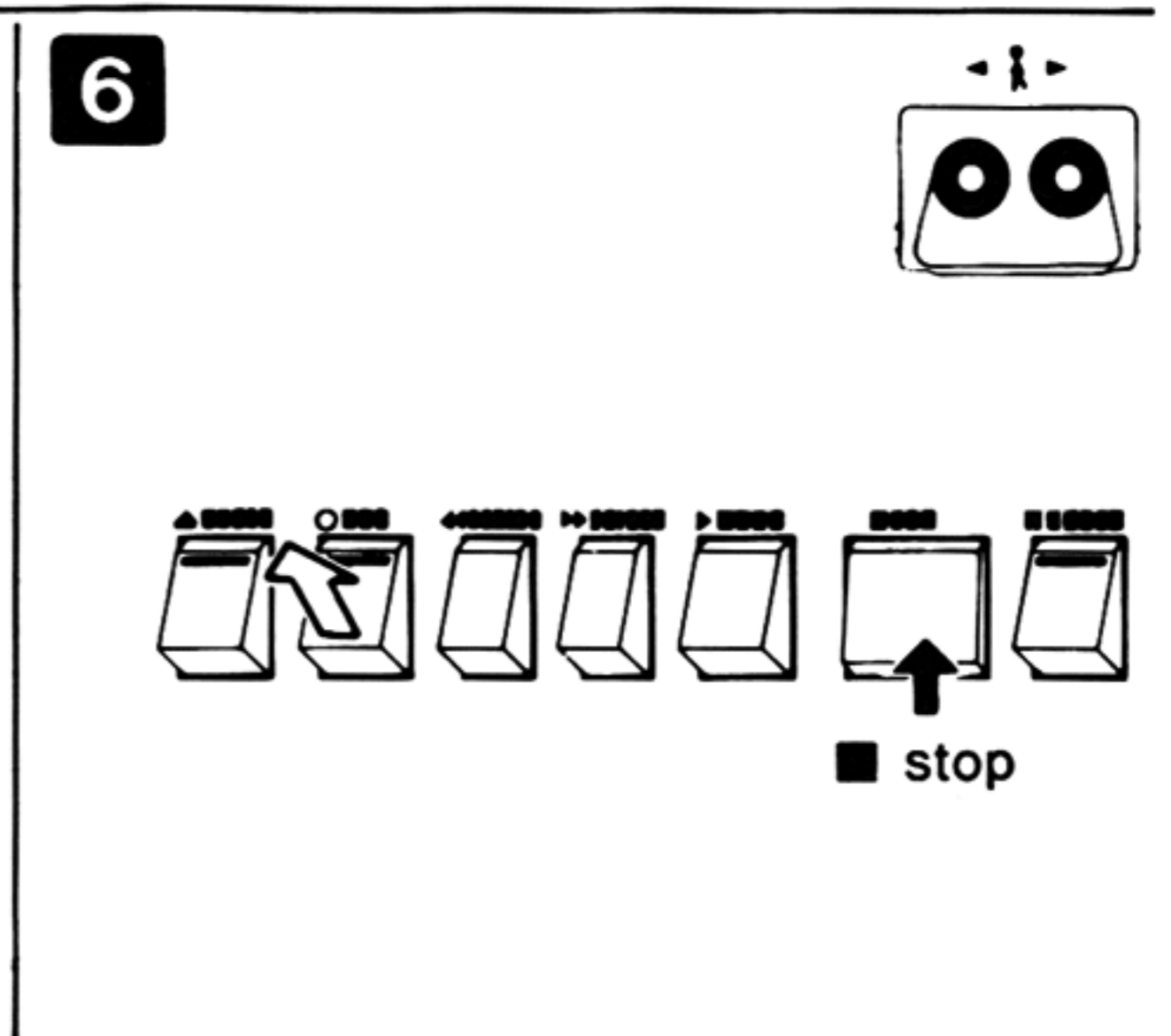

stop

(ENGLISH)

We want to thank you for selecting the model RS-M240X Technics cassette tape deck for your recording and playback enjoyment. To obtain the maximum benefit of the many features of this deck, please carefully read these operation instructions.

OPERATION NOTES

1. Horizontal placement

For best performance, place this unit in a horizontal position.

2. Location

Performance may be adversely affected by extremely hot [above 100°F. (35°C.)] or extremely cold [below 40°F. (5°C.)] locations, direct sunshine, or excessive vibration.

3. Power source

This unit features a DC operated motor which makes it possible to operate on 50 Hz or 60 Hz AC power frequency without any conversion. The voltage source should be within $\pm 5\%$ of the unit's rated voltage. Variations in excess of $\pm 10\%$ of rated voltage may cause uneven performance, or possible damage to the unit.

4. Clean the head assembly

One of the most important factors in the determination of good tape recorder performance is regular cleaning of the head assembly.

5. A "click" noise may be heard when the Power switch is turned on or off. To avoid this, be sure to set the volume control of the amplifier to the minimum position.

ABOUT CASSETTE TAPE (Refer to fig. 2.)

Notes:

- Do not pull the tape out of the cassette openings.
- If the tape is loose in the cassette, the tape may become wound onto the Pressure roller and result in breakage or damage. Tighten looseness of the tape, if necessary, by using a pencil as shown in the figure 2.
- Avoid using C-120 cassette tape with this unit because this tape can easily become broken, stretched or twisted if not used with extreme care.
- Avoid storing this unit in places where the temperature is high and/or where the humidity is high.
- If the tape is very tightly wound or unevenly wound, fast forward it and then rewind it before use.

MAINTENANCE (Refer to fig. 4.)

Cleaning the head section

Because the Head assembly and the Capstan are in constant contact with the moving tape, dirt or residue from the tape on these parts will decrease the sound quality. They should be cleaned after every 10 hours of use, as shown in figure 4.

Notes:

1. Don't allow magnetic materials, such as a screwdriver or a magnet, near the Head assembly.
2. When cleaning, be careful not to bend the tape guides.
3. Don't attempt to clean the cabinet with alcohol, benzine or thinner, because it may damage the finish. If the cabinet is dirty, clean with a soft cloth dampened with a soap-and-water solution.

CONTROL (Refer to fig. 5.)

- ① Power switch [power (push on)]
- ② Cassette holder
- ③ Tape counter and Reset button (tape counter)
- ④ Record indication lamp (rec)
- ⑤ FL (fluorescent level) meters
- ⑥ Microphone jacks [mic (left-right)]
- ⑦ dbx display lamp (dbx)
- ⑧ Headphones Jack (phones)
- ⑨ Eject button (▲ eject)
- ⑩ Record button (○ rec—□)
- ⑪ Rewind/Review button (◀◀ rew/rev)
- ⑫ Fast forward/Cue button (▶▶ ff/cue)
- ⑬ Play button (▶ play—□)
- ⑭ Stop button (■ stop)
- ⑮ Pause button (|| pause)
- ⑯ Input selector (input select)
- ⑰ Record-muting button [rec mute (○)]
- ⑱ Tape selector [tape select (Nor·Fe·Cr·CrO₂·Metal)]
- ⑲ Noise reduction selector switch [Noise Reduction (Dolby NR·out·dbx tape·dbx disc)]
- ⑳ Input level controls [input level (L → R)]
- ㉑ Line output jacks (LINE OUT) (R·L)
- ㉒ Line input jacks (LINE IN) (R·L)
- ㉓ Voltage selector (VOLTAGE SELECTOR)

CONNECTION NOTE (Refer to fig. 6.)

- Connections should be made in accordance with the connection diagram and the following instructions: When 2 microphones are used in order to record in stereophonic sound, be sure both of them have the same performance and specification standards.

Location of this unit and stereo amplifier

If this unit is placed on top of the stereo amplifier or next to it, a "hum" noise may be heard during tape playback. Refer to the information below in order to avoid this.

- (1) If the stereo amplifier and this unit are placed one above the other, leave as much space as possible between them, and place them where there is the least amount of hum.
- (2) If the stereo amplifier and this unit are placed one beside the other, try reversing their positions, and place them where there is the least amount of hum.

TAPE SELECTOR (Refer to fig. 7.)

In order to get the best performance from tape, and to record and playback with little distortion, the Tape Selector should be set as shown in figure 7.

Note that there may be a difference in sensitivity of 2 or 3 dB, depending on the type of tape.

“Metal tape” (Refer to fig. 8.)

A word about “Metal tape”

Conventional cassette tapes can be broadly classified into 2 categories according to the magnetic material coated on the tape surface: the ferric-oxide (γ -Fe₂O₃) type, including ordinary LH tape, etc.; and the chrome-dioxide (CrO₂) type, including XA tape, etc.

Continued technological advances have been made in an attempt to develop these tapes to a high level of performance, but recently there has been a recognized need for the development of a new material to improve performance much further.

In response to this need, “Metal tape” has been developed as a new kind of tape, employing a magnetic alloy of pure iron (Fe) as the main component in the magnetic substance. In comparison with conventional cassette tape, “Metal tape” can record a far greater amount of information at a high density. As a result, the maximum output level (MOL) has been improved throughout the entire range, and, in particular, the frequency response characteristics at high levels and the dynamic range in the high range have been greatly improved. This means, therefore, that a remarkable improvement of sound quality has been made possible. (It should be noted that the tape base and parts of the tape other than the magnetic substance are composed of the same material as previously used.)

CASSETTE INSERTION AND REMOVAL

(Refer to fig. 9.)

Notes:

- Be sure the cassette is placed so that the edge with the holes is facing downward. The Cassette holder cannot be closed if the cassette is inserted incorrectly.
- Be sure to close the Cassette holder gently.
- The operation buttons of this unit will not function if they are pressed while the Cassette holder is open.

Cassette ejection mechanism

Be careful not to press the Eject button while the tape is moving, because the cassette will stop the operation and the holder will open.

dbx noise reduction system

The dbx noise reduction system serves to greatly reduce the noise generated during recording and playback across the whole audible frequency spectrum (reduction by more than about “30dB”) and also to improve the linearity at high input levels. As a result, both recording and playback can be performed without impairing the wide dynamic range of the original sound. There are two kinds of dbx noise reduction system: “Type I” and “Type II”. “Type I” is used for open-reel decks and industrial applications while “Type II”, which is featured in this deck, is used for cassette applications.

Features

1. Reduced noise over the whole audible frequency range (more than about “30 dB” reduction).
2. The noise is compressed at a high recording level for recording to enable recording with minimal distortion and a wide dynamic range.
3. The linear logarithmic compression and expansion do not make the sound quality undergo change with level mismatching.

Principle of basic operation

The dbx system works to expand the dynamic range by compressing (encoding) the signals and then expanding (decoding) them. As shown in the figure, the input signal level is halved during recording onto the tape. During playback the halved level is doubled to restore the original signal. The figure shows that high signals are greatly expanded (from “+10 dB” to “+20 dB”) while low signals are given a low expansion (“-40 dB” to “-80 dB”). This results in a great improvement in the dynamic range and simultaneously in a great reduction in tape hiss.

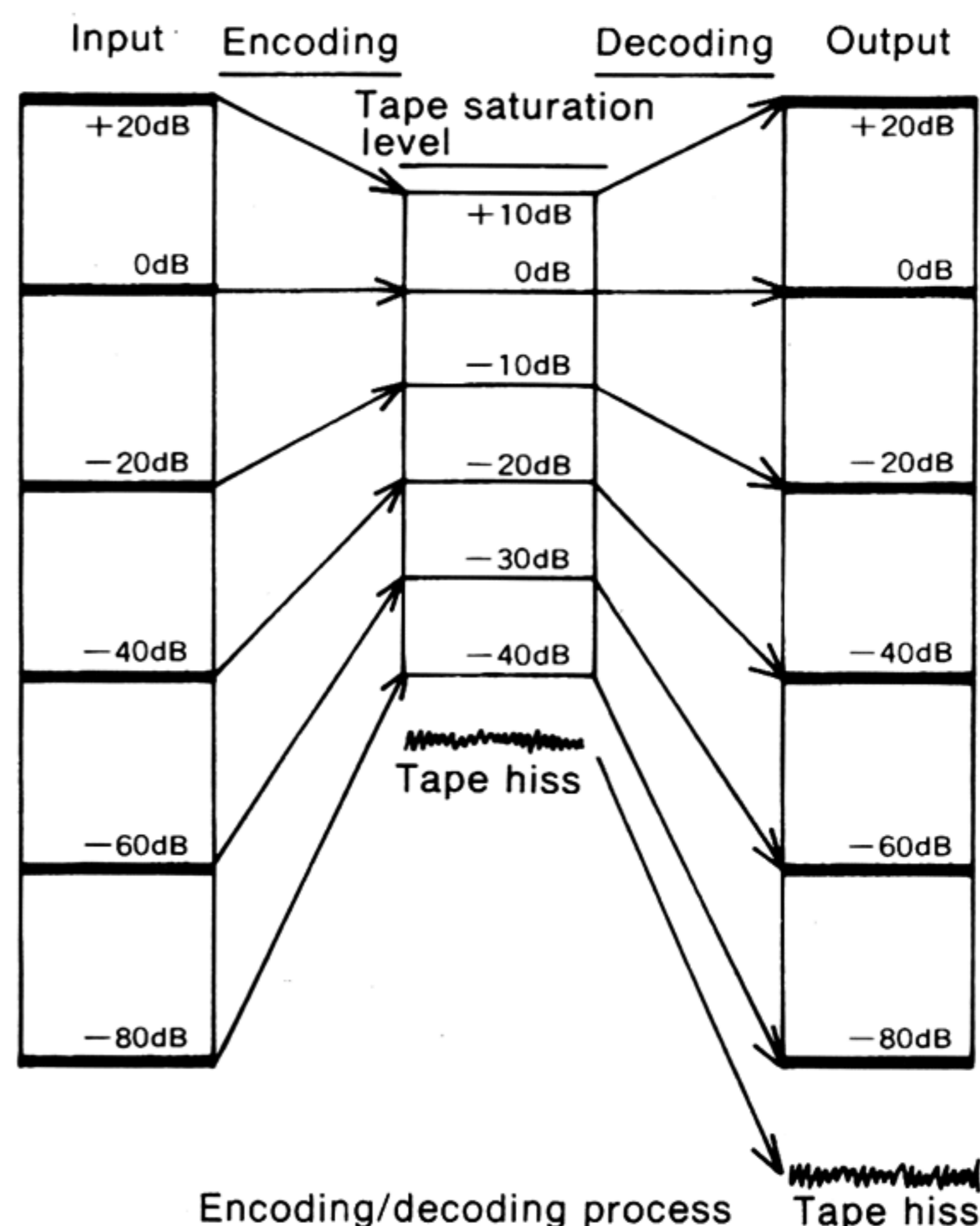

"disc" position for "dbx encoded disc" play

This unit comes with a "disc" position on the Noise reduction selector switch for playing "dbx encoded discs".* When this selector switch is set to the position given in the figure below, "dbx encoded discs" can be played.

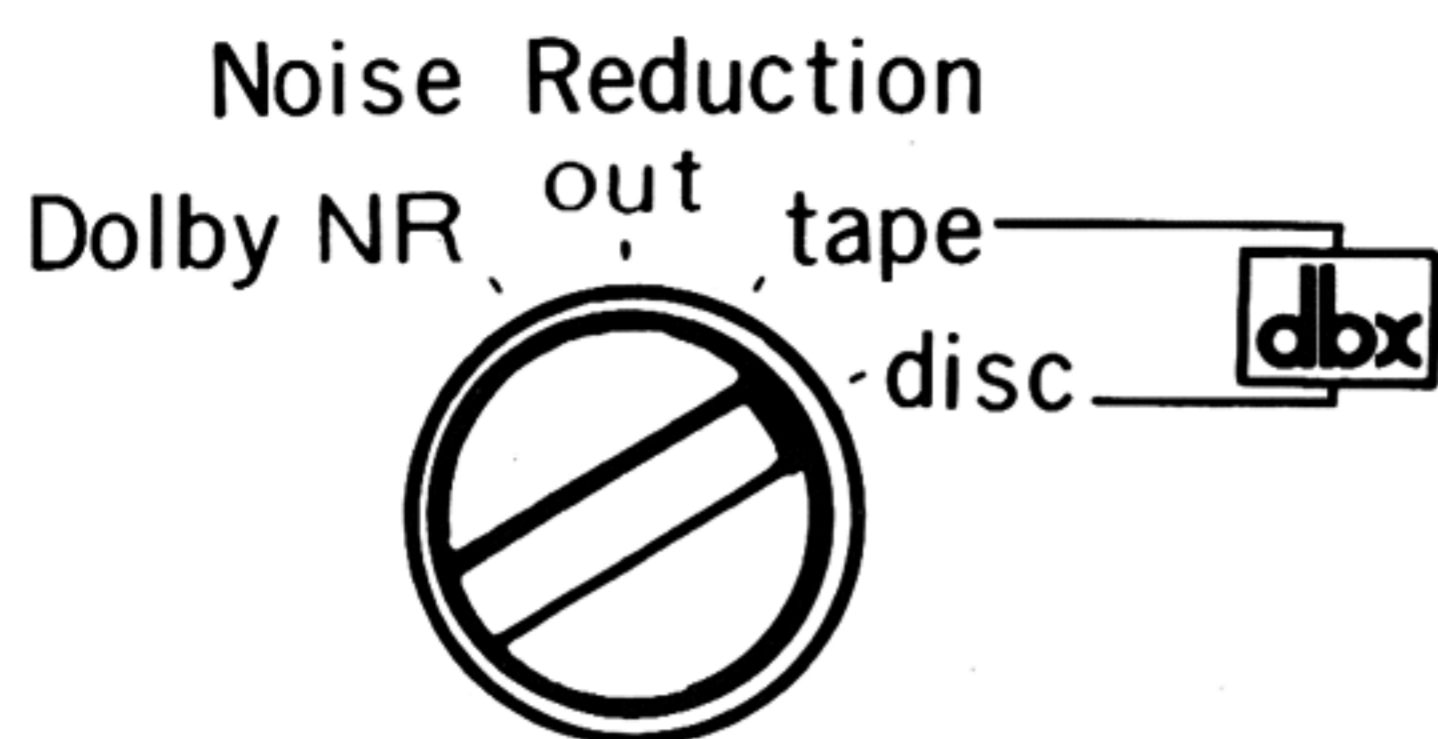

Follow the procedure given below.

- (1) Set the recording output selector switch on the stereo amplifier to the "phono" position and set the input selector switch or tape monitoring switch to the "TAPE" position.
- (2) Set this unit's Input selector to the "line" position and set the Noise reduction selector switch to the "disc" position.
- (3) Start operating the turntable.
- (4) Adjust the unit's Input level controls so that the FL meter scales deflect to near "0 dB".
- (5) Adjust the volume using the volume control on the stereo amplifier.

Now set the mechanism to the stop mode.

Some open-reel type dbx encoded tapes are now available from music stores. These tapes can be played back just like the records by setting the Noise reduction selector switch to the "disc" position.

Notes

- If the Noise reduction selector switch is set to the "disc" position during ordinary tape playback, the playback sound will not be audible.
- If the mechanism is operated during "disc" play, it will work but the tape playback sound will not be audible. If the Record button is depressed and the deck set to the recording mode, the decoded sound (the now restored original sound) will be recorded. When playing back this sound, set the Noise reduction selector switch to the "out" position.
- If the Record button is depressed when you are listening to records with the Noise reduction selector switch at the "disc" position, the sound will be cut off for an instant. This is not a malfunction.
- To record "dbx encoded records" using the dbx noise reduction system, first set the Noise reduction selector switch to the "out" position and start recording. This makes it possible to record in the encoded state. For playback, set the selector switch to the "tape" position. The recording level should be set as follows:

First set the Noise reduction selector switch to the "disc" position and adjust the Input level controls to around "-3 dB" so that the FL meter scales do not exceed "0 dB" at peak times. Now set the Noise reduction selector switch to the "out" position again and proceed with the recording.

Sounds monitored while recording "dbx encoded records" are encoded (compressed) sounds, not decoded sounds.

*"dbx encoded discs (records)" differ from ordinary records in that dbx noise reduction encoding (compression) is performed when the signals are cut into the records. During play, these signals pass through a decoder and the original sound is restored. This makes for a virtually noise-free sound, a wide dynamic range and better music reproduction.

Expansion in dynamic range

The figure below shows the dynamic range characteristics. First the overall frequency response is indicated at a signal level where the distortion is made 3% at 1 kHz.

When the "dbx in" position is selected, there is an increase of about 13 dB at the 3% point over the "out" position, indicating that the distortion with high input levels is greatly improved.

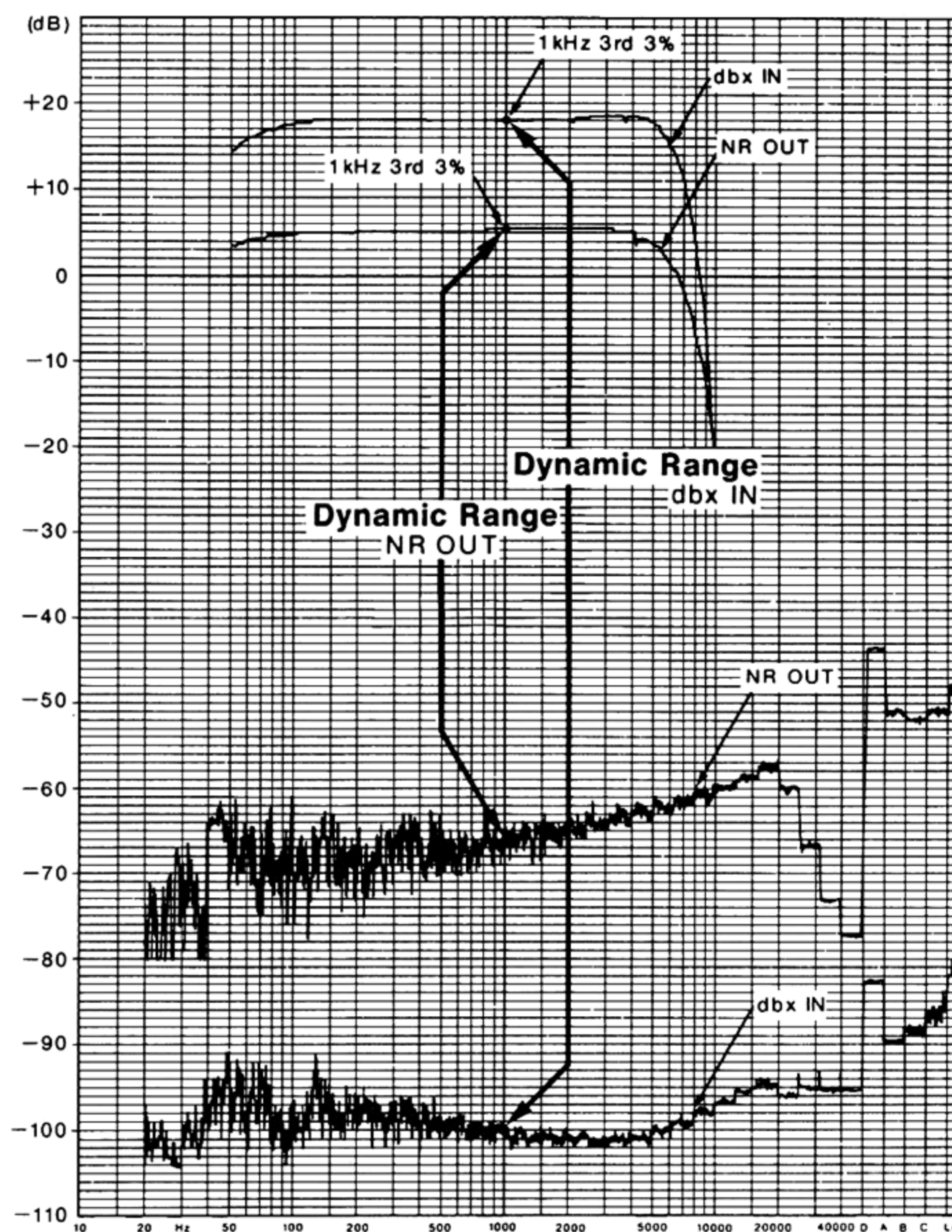

In addition, the noise distribution is indicated at the "dbx in" and "dbx out" positions when the noise level is recorded without any signals being supplied and that noise on the tape is played back.

With recording and playback at the "dbx in" position, it is clear that the noise level is greatly reduced. Because of the great reduction in the noise level and the great expansion in the signal level, the dynamic range at the "dbx in" position is vastly improved, and a dynamic range which is vastly superior to that of a 2-track 38 cm/sec. open-reel tape is yielded.

Notes:

- There is no compatibility between the dbx noise reduction system and other similar systems. Tapes recorded with the dbx system should therefore be played back with the dbx system.
- Record ordinary discs (not "dbx encoded discs") with the Noise reduction selector switch at any position except "disc." The sound quality will change if this switch is set to the "disc" position for ordinary record play.

PLAYBACK (Refer to fig. 10.)

Notes:

- Note that the operation buttons will not function until about 5 seconds have passed after the power is turned on.
- To listen to the playback sound with headphones, connect stereo headphones to the Headphones jack. Sound can then be heard directly from the unit, without connection to an amplifier if an amplifier is connected its controls have no effect upon the sound heard from the headphones.
- When the power is not being supplied to the unit and when the Record button or Play button is depressed, and then the Stop button is depressed and then the power is switched on, the head section may operate. However, this does not indicate that there is anything wrong with the unit.
- If the Record button or the Play button is depressed immediately after the power has gone off, the head section will remain raised. This means that the tape will not be ejected even when the Eject button is depressed. In cases like this, switch on the power again.
- Set the noise reduction selector switch to "Dolby NR" when using the Dolby system and to "dbx tape" when using the dbx system. Refer to page E2, 3 for instructions on use at the "dbx disc".

FAST FORWARD AND REWIND

(Refer to fig. 11.)

Cautions:

- Do not push the Eject button during the fast forward or the rewind operation. Before pushing the Eject button, be sure to first stop the tape by pushing the Stop button.
- The pause function does not work when the unit is set to the fast forward or rewind mode.

"CUE" AND "REVIEW" (Refer to fig. 12.)

When the Fast forward/Cue button (or Rewind/Review button) is pushed during playback, the playback sound can be monitored through the speaker as the tape is sent forward (backward).

Note:

- Reduce the volume level of the stereo amplifier before performing the "cue" or "review" operation. If the volume is too high, the tweeters in the speaker systems may be damaged.

REWIND/AUTOMATIC PLAYBACK

(Refer to fig. 13.)

To again playback tape after recording or playback, push the Play button and the Rewind/Review button at the same time. The tape will be rewound and playback will automatically begin.

RECORDING (Refer to fig. 14.)

- Make the adjustment so that the meters illuminate until the "+6 dB" indication when the input signal level is the greatest, using the Input level controls. (Refer to fig. 14-7-①.)
- For recording of chamber music (such as a string quartet), and other music in which there is very little percussion sound, adjust so that the level is slightly lower (to an illuminated indication up to "+3 dB").
- If the fluorescent level meters show an illuminated indication of only up to about "0 dB" when a loud sound is received, the recorded results will be rather noisy (with a poor signal-to-noise ratio). (Refer to fig. 14-7-②.)
- If, conversely, the fluorescent level meters continuously shown an illuminated indication up to "+8 dB," the recorded results will be rather distorted. (Refer to fig. 14-7-③.)

Notes:

- After making a valuable recording, it is suggested that the accidental-erase prevention tabs be broken out, using a screwdriver or similar tool, in order to prevent accidental erasing of the recording by later re-recording over it.
- For recording, therefore, be sure that the cassette has the tabs intact, or that the holes (where the tabs were) are covered by cellophane tape.

Recording muting

The recording-muting feature is convenient to prevent recording such unwanted material as commercial messages when recording FM radio broadcasts, or the "click" noise heard when the stylus descends to the disc surface.

How to make blank (no sound recorded) spaces

Immediately after one program has been recorded, keep the Record-muting button depressed for about 5 seconds. After these 5 seconds have elapsed, depress the Pause button.

Fluorescent level meters

The unit's level meters employ fluorescent display tubes to indicate the input and output signal levels in the form of a bar graph.

During playback the playback level is indicated, and during recording the recording level is indicated.

This unit's meter is designed for "peak" indication. With peak indication, the level meters respond sensitively to rapid bursts of sound such as that from percussion instruments and so it is possible to record up to near the tape's saturation level with very little distortion and a good signal-to-noise ratio. Furthermore, the unit is provided with an auto reset peak hold function. In order to facilitate recording level readout, the peak level—apart from the illumination of the meters—can be held on the meter for about 2 seconds. During this time the peak level can easily be read out.

Based on a reference of "0 dB", the unit's fluorescent display meters have markings in two colors for easy instantaneous readout.

Monitoring

To listen to the recording as it is being made, simply connect stereo headphones ($8\Omega\sim 125\Omega$) to the Headphones jack.

You may also listen to the program as it is being recorded if your receiver or amplifier is equipped with a tape-monitor switch.

Note:

In the same way as for playback, an amplifier can also be used for monitoring.

Automatic-stop system (Full-auto-stop system)

This unit has an automatic-stop system which, when the tape comes to its end during recording, playback, fast forward or rewind, releases the tape-transport mechanism automatically and places the unit into the stop mode.

- Because the mechanism automatically stops when the tape comes to its end, both the operating parts and the tape itself are protected. This unit is free from problems such as Pressure roller deformation resulting from leaving the unit in the stop condition (without pushing the Stop button) for a long period of time.

TIMER PLAYBACK AND RECORDING

(Refer to fig. 15.)

- When preparing for timer playback, first play the tape in order to adjust (by using the controls on the stereo amplifier) the volume and tone as desired. When these adjustments are finished, rewind the tape to the position from which the timer playback is to begin.
- Set the timer to the desired time. (Depending upon the type of timer, the power to the amplifier, tape deck and tuner will then be turned off.)
Refer to the operation instructions of the timer for further information.
- This completes the preparations for timer recording or playback. At the desired time, the power will be turned on and the timer recording or playback will begin.

ERASING (Refer to fig. 16.)

Use the "CrO₂" position for erasing normal tapes, ferrichrome tapes and chrome tapes.

Use the "Metal" position to erase "Metal tape."

Recording with Dolby NR

This unit includes the Dolby noise-reduction system, which reduces tape noise to a remarkable degree.

Briefly, the system works as follows: At low sound levels (where tape noise is most noticeable), the high-frequency portion of the sound is recorded at a higher level. Tape noise is not amplified.

During playback, the level of only that portion of the signal which was increased at the time of the recording, as well as tape noise, is reduced by a like amount. This causes the signal to be heard at a normal level, and the tape noise to be reduced significantly.

TROUBLESHOOTING

If operation of this unit does not seem normal, check the following points before requesting service. If the trouble cannot in this way be determined and corrected, contact the dealer from whom the unit was purchased.

- 1. After the tape cassette is inserted, the tape does not move when the Play button is pushed.**
 - Is the Power cord correctly connected?
 - Is the Power switch pushed in to the "on" position?
 - Is the Pause button released?
- 2. Although the tape moves, no sound is heard.**
 - Is the tape blank?
 - Are the connections of amplifier and speakers correct?
 - Are connection cords from this unit to the amplifier correctly connected?
 - Is the volume control of the connected amplifier set to the correct position?
 - Is the monitor switch of the connected amplifier set to the correct position?
 - Has the Noise reduction selector switch been set to the "dbx disc" position?
- 3. Sound is distorted.**
 - Is the recording level too high?
 - Is the input impedance of the connected amplifier appropriate?
- 4. The Record button cannot be pushed down.**
 - Is the tape cassette inserted correctly?
 - Have the recording-prevention tabs of the cassette been removed?
- 5. Tape moves, but no sound can be recorded.**
 - Is the Input selector set to the incorrect position?
- 6. Playback sound is hoarse or vibrates. Recorded sound is not clear.**
 - Are the head surfaces dirty?
 - Is foreign material adhered to the Pressure roller and/or the Capstan?
 - Has the cassette tape been wound too tightly on the reels?
 - Is the Noise reduction selector switch set correctly to playback the recorded encoded material?

SPECIFICATIONS

Track System:	4-track 2-channel stereo recording and playback
Tape Speed:	4.8 cm/s
Wow and Flutter:	0.048% (WRMS) \pm 0.14% (DIN)
Frequency Response:	Metal tape; 20–18,000 Hz 30–17,000 Hz (DIN) 30–16,000 Hz \pm 3 dB CrO ₂ tape ; 20–18,000 Hz 30–16,000 Hz (DIN) 30–16,000 Hz \pm 3 dB Normal tape; 20–17,000 Hz 30–15,000 Hz (DIN) 30–14,000 Hz \pm 3 dB
Dynamic Range:	110 dB (at 1 kHz)
Max. Input Level:	10 dB or more improved with dbx in (at 1 kHz)
Signal-to-Noise Ratio:	dbx in; 91 dB Dolby NR in; 67 dB (above 5 kHz) Dolby NR out; 57 dB (signal level = peak level A weighted, CrO ₂ type tape)
Fast Forward and Rewind Time:	Approx. 90 seconds with C-60 cassette tape
Inputs:	MIC; sensitivity 0.25 mV, input impedance 47 k Ω applicable microphone impedance 400 Ω –10 k Ω
Outputs:	LINE; sensitivity 60 mV, input impedance 47 k Ω LINE; output level 400 mV, output impedance 1.5 k Ω or less load impedance 22 k Ω over HEADPHONES; output level 80 mV, load impedance 8 Ω
Bias Frequency:	80 kHz
Motor:	Electronically controlled DC motor
Heads:	2-head system 1 SX head for rec/playback 1 double-gap ferrite head for erasure
Power Requirement:	AC 110/125/220/240 V, 50-60 Hz Preset power voltage; 220 V for Europe Preset power voltage; 240 V for Australia
Power Consumption:	15 W
Dimensions (W \times H \times D):	43 cm \times 11.9 cm \times 24.6 cm
Weight:	4.6 kg

Specifications are subject to change without notice.

* Dolby noise reduction system manufactured under license from Dolby Laboratories.

NOTICE: (For United Kingdom)

The apparatus was produced to B.S. 800: 1977.

NOTICE: (Pour la France)

"La société NATIONAL-PANASONIC-FRANCE, importateur du matériel MATSUSHITA declare que cet appareil est conforme aux prescriptions de la directive 76/889/C.E.E. (arrêté du 14 Janvier 1980)."

AVERTENZA: (Per l'Italia)

La Società NATIONAL PANASONIC ITALIANA, importatrice di questo prodotto, dichiara che, questo apparecchio è conforme alle prescrizioni della direttiva 76/889/C.E.E. (D.M. del 9 ottobre 1980)



Matsushita Electric

Matsushita Electric Trading Co., Ltd.
P.O. Box 288, Central Osaka, Japan



Printed in Japan
QQT3085 S0481T0